

# 炬光科技介绍

© 西安炬光科技股份有限公司

2024-11

- 国家级高新技术企业，成立于2007年9月，由刘兴胜博士带领留学人员发起创立。
- 主要从事光子产业链上游的**高功率半导体激光元器件和原材料**（“产生光子”）、**激光光学元器件**（“调控光子”）的研发、生产和销售。
- 积极拓展光子产业链中游的**光子应用模块、模组、子系统**（“提供光子应用解决方案”）的研发、生产和销售，重点布局光通信、汽车应用、泛半导体制程、医疗健康。
- **全球光子工艺和制造服务中心**，为世界各地的光子行业客户提供量身定制的全球制造服务。
- 上海证券交易所科创板上市公司（股票代码：688167）。





## 西安炬光科技股份有限公司

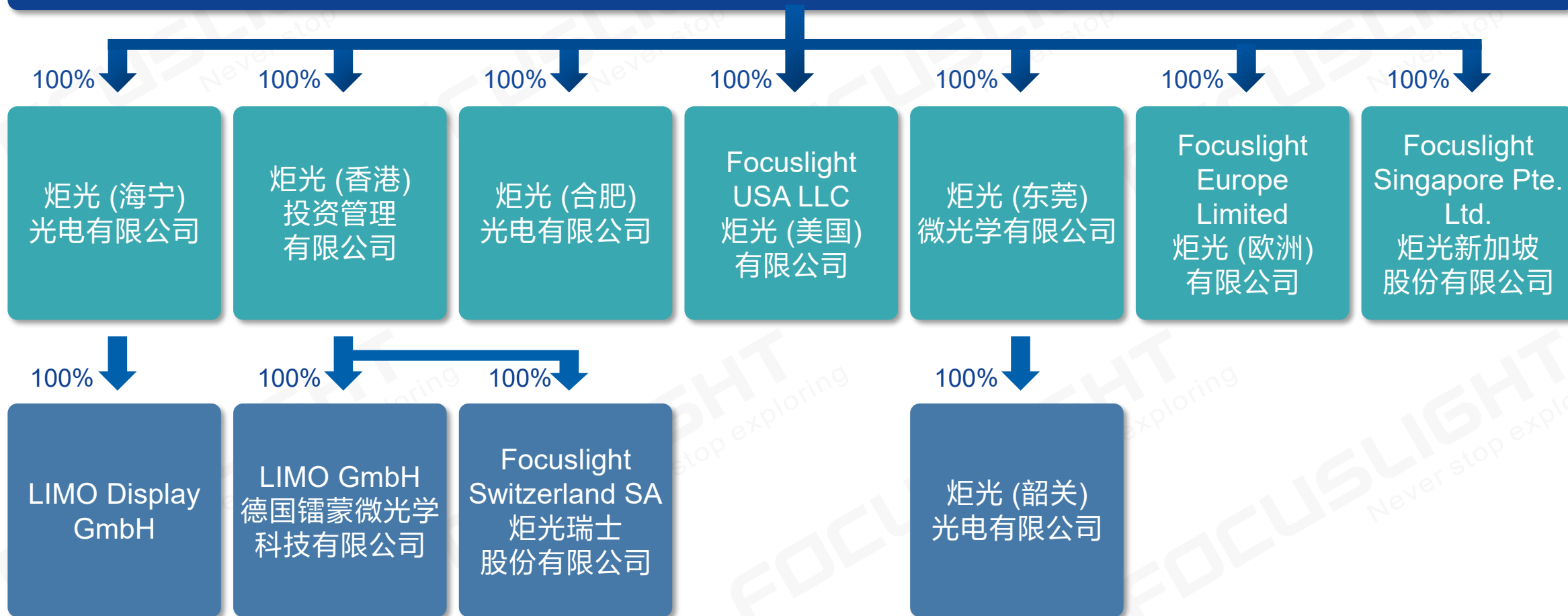

# 炬光科技全球运营体系

通过全面集成整合，健全和优化炬光科技全球运营体系；

通过集中决策、一体化运作和精益管理，形成强创新、高效率、低成本的全局运营体系。



瑞士，纳沙泰尔  
运营中心



德国，多特蒙德  
运营中心



中国，西安  
炬光科技总部（管理、研发、商务、运营）



中国，海宁

中国，合肥  
研发中心、运营中心  
(建设中)

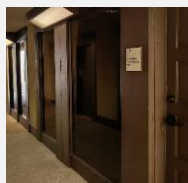

美国，硅谷  
创新实验室



瑞士，苏黎世  
研发办公室



新加坡，宏茂桥  
研发、商务和运营中心

东南亚其他区域 (待定)  
光子工艺和制造服务运营中心



中国，韶关  
研发中心、运营中心



中国，东莞  
研发中心、运营中心



# 关键数据



员工人数  
**>900**



近三年研发费用占比  
**~16%**



上一年度 (2023)  
实现销售额  
**5.61** 亿元



有效授权专利  
**>610**



厂房面积  
**>48,000m<sup>2</sup>**  
洁净室面积  
**>14,000m<sup>2</sup>**



ISO 9001  
ISO 14001  
ISO 45001  
IATF 16949  
认证 + ERP 管理

愿景

FOCUSLIGHT  
Never stop exploring

让人们的生活  
离不开光子





使命

FOCUSLIGHT  
Never stop exploring



通过技术创新、  
卓越制造和快速响应，  
成为全球可信赖的  
光子应用解决方案提供商



# 应用方向



先进制造

64%  
销售额占比

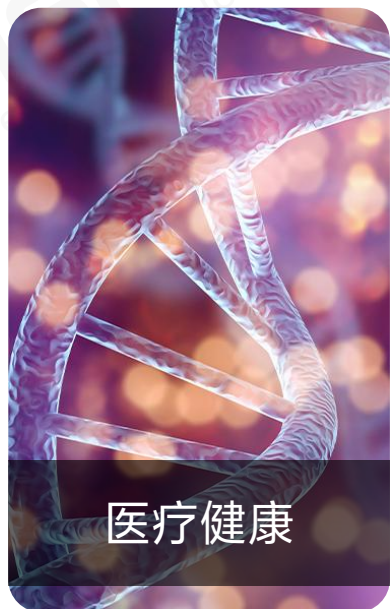

医疗健康

12%  
销售额占比

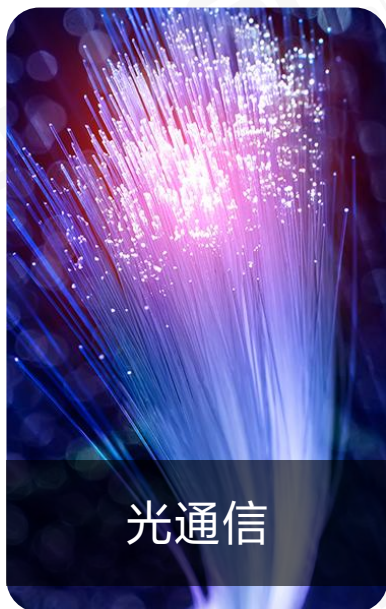

光通信

4%  
销售额占比



汽车应用

15%  
销售额占比

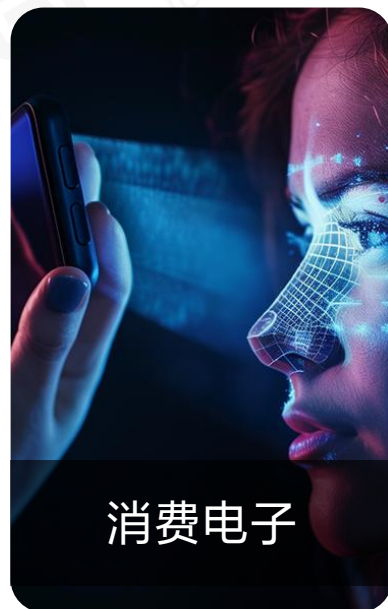

消费电子

1%  
销售额占比

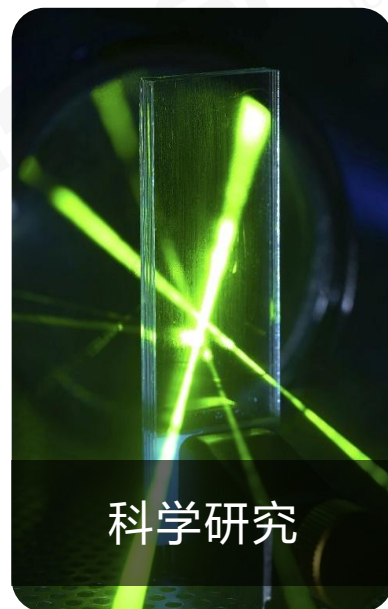

科学研究

4%  
销售额占比

\* 根据公司 2024 Q1 – Q3 财务数据计算

# 管理团队

	<p><b>刘兴胜博士</b> 董事长、总经理</p> <p>美国康宁、相干、恩耐研发与管理经验，发表学术论文100余篇，专利300多项以及30多篇国际受邀报告</p> <p>中国光学学会理事，中国激光加工专业委员会常务委员、SPIE和IEEE技术委员会委员</p> <p>  </p>		<p><b>石钟恩博士</b> 首席科学家</p> <p>美国康宁、贝尔实验室30多年的研发与管理经验，发表学术论文400余篇，拥有50余项在光电子器件和光通信领域的专利</p> <p>IEEE Fellow, OSA Fellow, 2次 R&amp;D 100 奖获得者</p> <p>  </p>
	<p><b>Reinhard Voelkel 博士</b> 首席战略官</p> <p>35年以上微纳光学行业技术开发与企业经营经验，全球微纳光学行业领军人物，发表多篇微纳光学领域论文</p> <p>     </p>		<p><b>Sinclair Vass</b> 海外销售及商业拓展高级副总裁</p> <p>35年以上国际光子行业业务经验</p> <p>曾任职惠普、JDSU、朗讯、Velodyne等多家大型跨国公司并担任技术、业务高级管理职务和总经理职务</p> <p>   </p>
	<p><b>朱国巍</b> 质量副总、汽车事业部总经理</p> <p>20余年国际汽车公司经验，丰富的工厂运营管理经验</p> <p>熟悉IATF质量管理体系、KPI绩效管理、团队建设、精益生产和世界级制造(WCM)</p> <p>  </p>		<p><b>田野</b> 董事、全球销售副总裁、中国区销售总监</p> <p>全球500强企业多年管理经验，在市场拓展、产品营销和销售管理上经验丰富</p> <p>两次荣获“飞利浦照明大中华区杰出表现奖”</p> <p></p>
	<p><b>叶一萍</b> 董事、首席财务官</p> <p>15年以上企业管理经验+多领域业务实践</p> <p>熟悉LTC及IPD流程管理及跨文化合作，对市场开发，项目运作及企业管理有深入的理解和丰富的运作经验</p> <p> </p>		<p><b>Qichuan Yu</b> 首席产品官、首席工艺官</p> <p>在晶圆级光学元器件、光学传感器和相机封装、SAW/BAW滤波器研发领域拥有超过25年经验，尤其擅长母版制作、tooling和晶圆级制造</p> <p>   </p>



# 管理团队

	<p><b>张雪峰</b> 董事会秘书、市场总监</p> <p>14年光电行业国际业务工作经验，对市场、销售、业务拓展有深入的理解和丰富的经验</p> <p>曾入选西安市海外高层次人才引进“5211计划”</p>  		<p><b>张健</b> 全球运营中心总监</p> <p>近20年全球供应链管理经历</p> <p>曾任职多家世界500强企业，在消费电子行业全球供应链策划和管理上拥有丰富经验及出色业绩</p>   
	<p><b>曲进超</b> 半导体激光事业部总经理、医疗健康事业部总经理</p> <p>全球500强企业多年产品营销与销售管理经验，曾任公司亚洲区销售总监、应用系统军团负责人，均拥有出色业绩</p>  		<p><b>Dirk Walter Bogs</b> 激光光学事业部总经理</p> <p>25年以上超精密工具、光学制造、工程和项目管理、运营管理经验</p> <p>对技术开发和优化有非常深入的见解</p> <p>丰富的国际合作经验</p> 
	<p><b>田勇</b> 激光光学事业部副总经理</p> <p>20年运营及研发管理工作经历</p> <p>熟悉有机光学材料及光学镀膜技术，发表SCI文章和拥有专利技术</p> <p>在精益生产及工业4.0的规划及推行上有丰富经验</p>  		<p><b>戴晔</b> 泛半导体制程事业部总经理</p> <p>在全球销售和产品线管理等方面拥有出色的业绩</p> <p>拥有已授权专利20项，其中发明专利5项</p>  
	<p><b>Tobias Senn 博士</b> 战略增长部副总经理</p> <p>15年以上消费类微光学元件产品开发经验，擅长制造和工艺开发的设计，特别关注大批量生产和良率的提高</p>    		<p><b>Hongyuan Liu (Tom)</b> 全球光子工艺和制造服务事业部总经理</p> <p>20多年研发和运营管理经验，专注于光学成像和非成像系统设计、晶圆级光学（WLO）工艺与集成以及光学元件制造，在新产品开发和大规模量产方面拥有卓越业绩</p>    



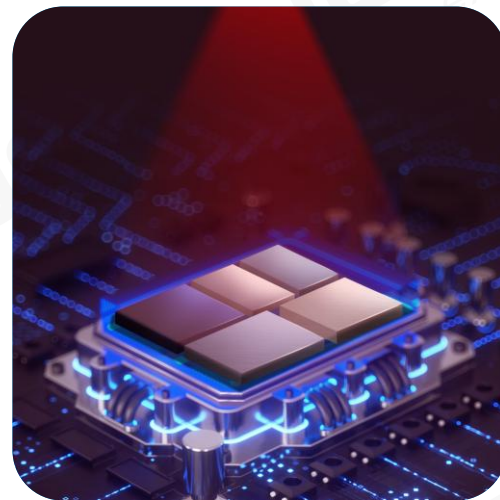
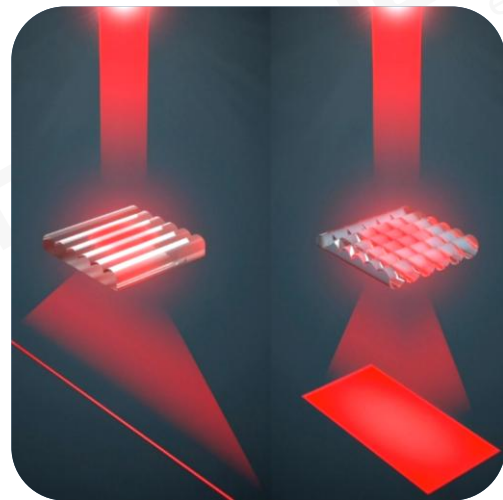
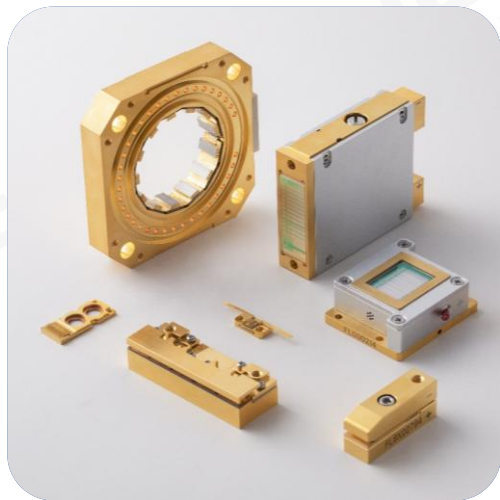

产生光子



调控光子



光子技术应用  
解决方案



全球光子  
工艺和制造



## 做自己擅长的事

追求卓越

不断优化改进

实现更高性能或性价比

## 对客户的承诺

- 更低成本、大批量生产制造
- 如客户承诺市场份额，我们愿意承担技术风险
- 如客户承诺市场份额，我们愿意承担研发和资本投资（包括并购）风险
- 协作透明，快速响应，保护知识产权，长期合作共赢



## 不做

高市场风险业务

贪心不足的事

过于激进的事

与客户竞争的业务

**FOCUSLIGHT**  
Never stop exploring

所有由炬光科技设计的产品和业务将在全球范围内统一使用Focuslight品牌，从而提高效率，增强协同。

 **HEPTAGON**  
A FOCUSLIGHT BRAND

将客户的创意和设计转化为其自身产品和解决方案的全球光子工艺和制造服务将在全球范围内统一使用Heptagon品牌。



## 炬光科技

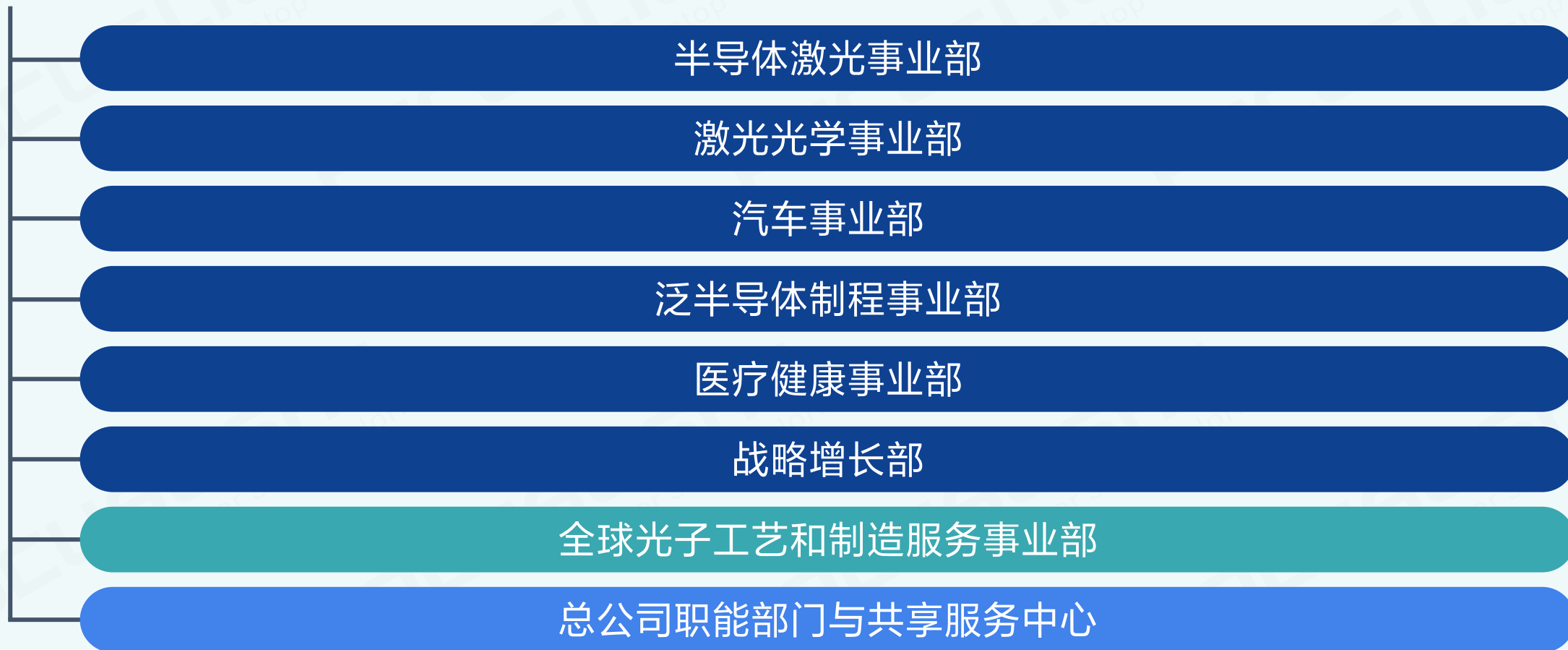

# 核心竞争力

核心技术 – 半导体激光

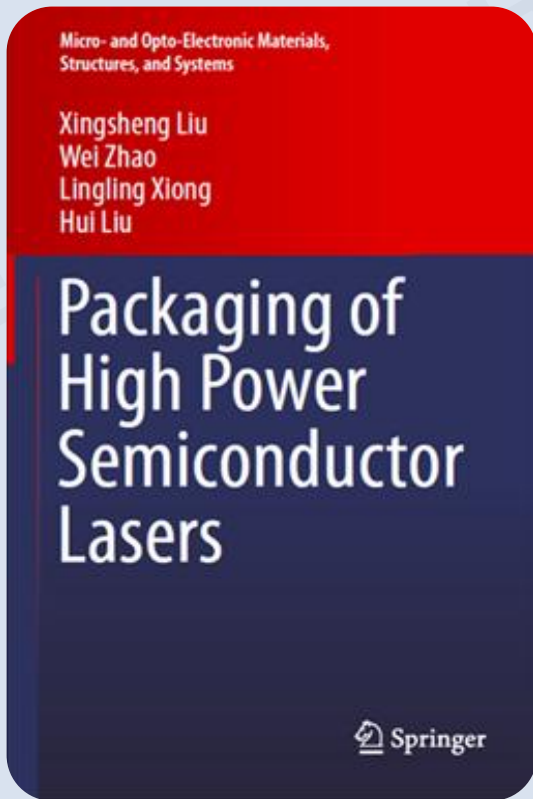

世界第一本高功率半导体激光器封装专著

## 共晶键合技术

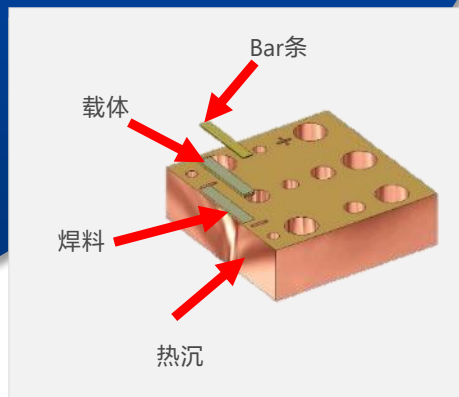

## 热管理技术

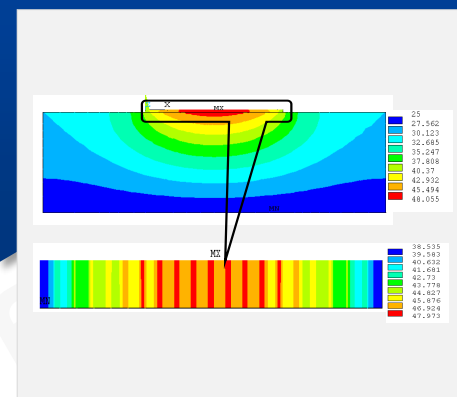

## 热应力控制技术

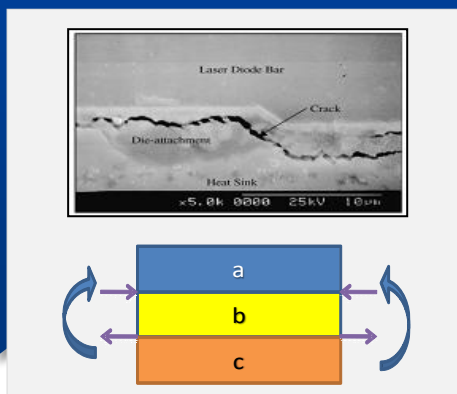

## 界面材料与表面工程技术

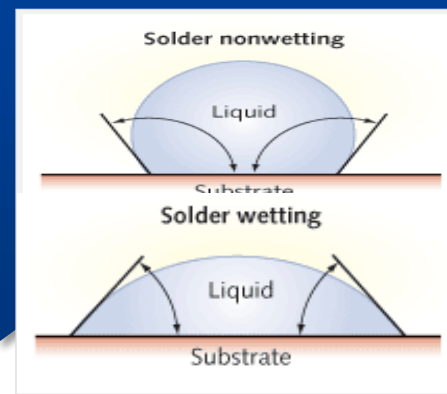

## 测试分析诊断技术

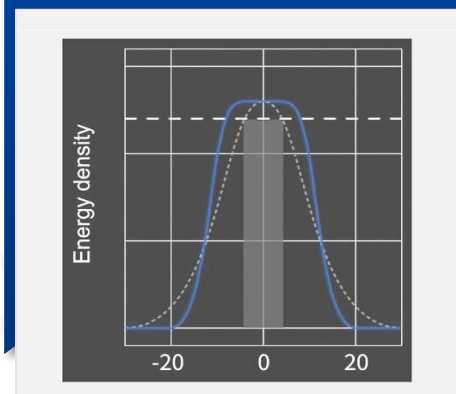

# 核心竞争力

核心技术 – 光学整形

将合适的光子在合适的时间传递到合适的位置!

## 微纳光学设计与模拟

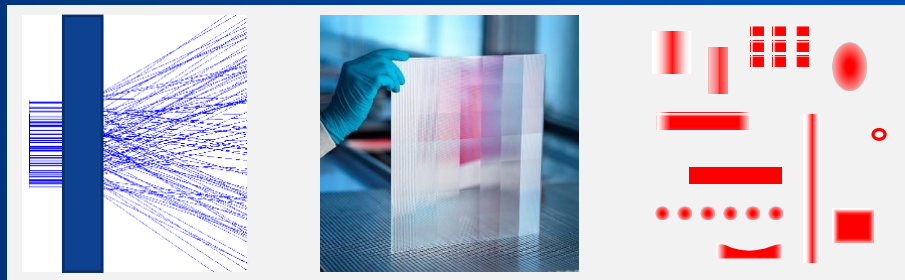

高精度自由曲面微光学与光束整形系统

## 光场匀化技术

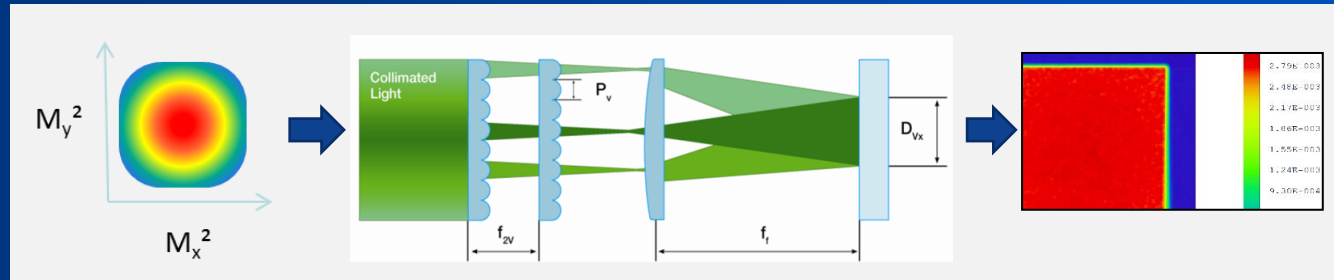

可实现各种几何形状光斑的匀化输出为世界先进半导体光刻设备提供光场匀化系统

## 光束转换技术

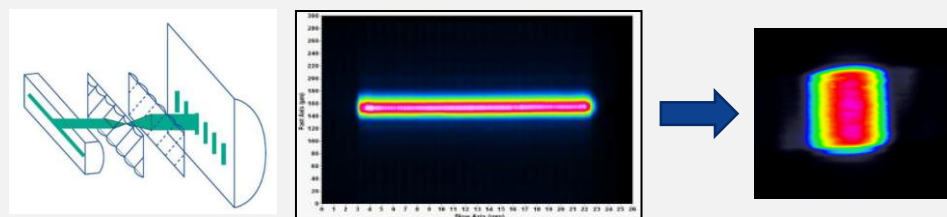

将极端不对称的光束转变为基本对称光束

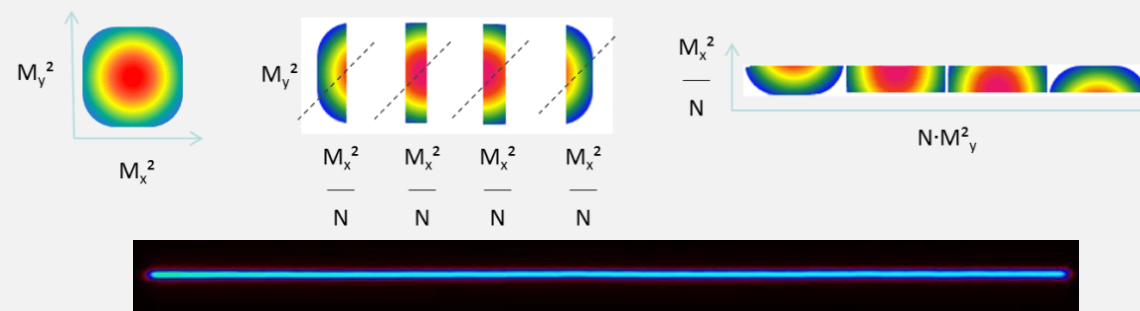

将对称光整形和转化为超均匀高密度线光斑



# 核心竞争力

核心技术 – 光学整形

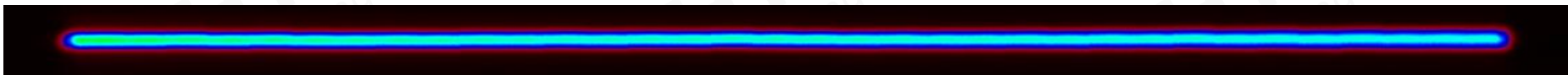

线光斑整形技术

UV-L750产品获得2018年 PRISM AWARDS奖

# 核心竞争力

核心技术 – 光学制造

晶圆级同步结构化激光  
光学制造技术

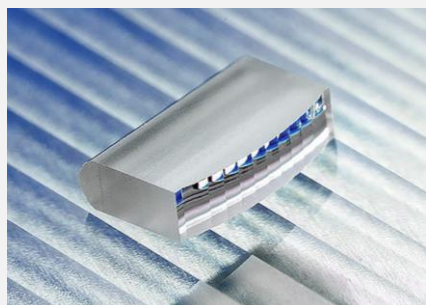
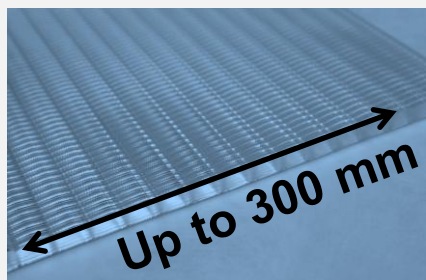

光刻-反应离子蚀刻法  
晶圆级微纳光学  
精密加工制造技术

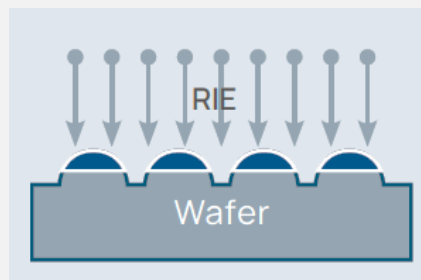

精密模压

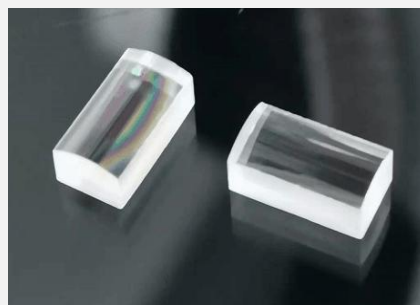

冷加工

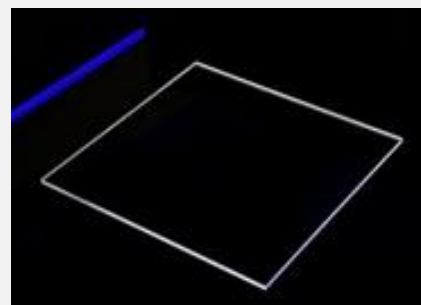

压印精密微纳光学设计  
与加工制造技术

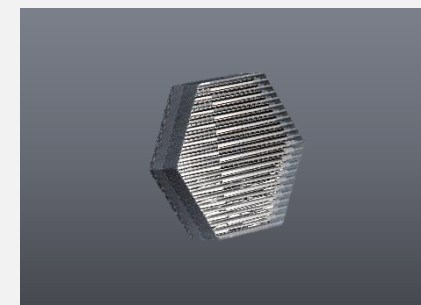
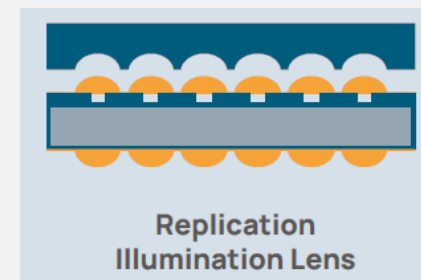

无机材料: 玻璃、熔融石英、硅、氟化钙等

玻璃基底聚合物 (PoG)

高损伤阈值光学镀膜能力: 增透膜、高反射膜、分光膜、干涉滤光膜等 (UV, VIS, IR)

# 核心竞争力

## 晶圆级光学元器件及晶圆级透镜堆叠

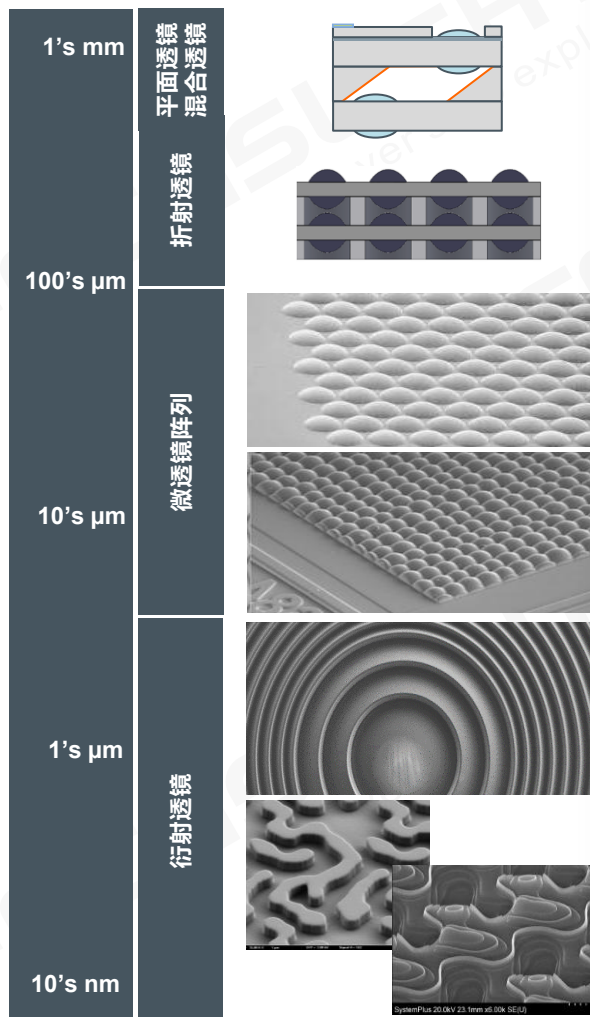

晶圆级光学元器件，晶圆级集成封装，晶圆级检测工艺



毫米至纳米尺度晶圆级压印精密光学元器件

晶圆级光学元器件  
(WLO)

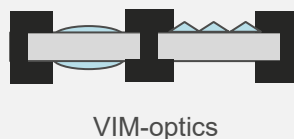

衍射与折射光学、微透镜阵列 (MLAs)、  
光束扩散器

晶圆级透镜堆叠  
(WLS)

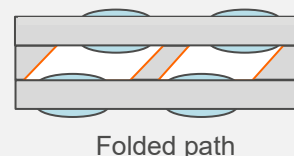

成像透镜组、投影透镜组

晶圆级透镜集成  
(WLI)

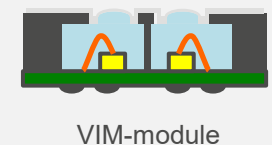
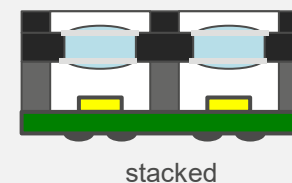

光学传感及照明模组



# 核心竞争力

高精度光学装配工艺及自有装备：从元器件到子系统

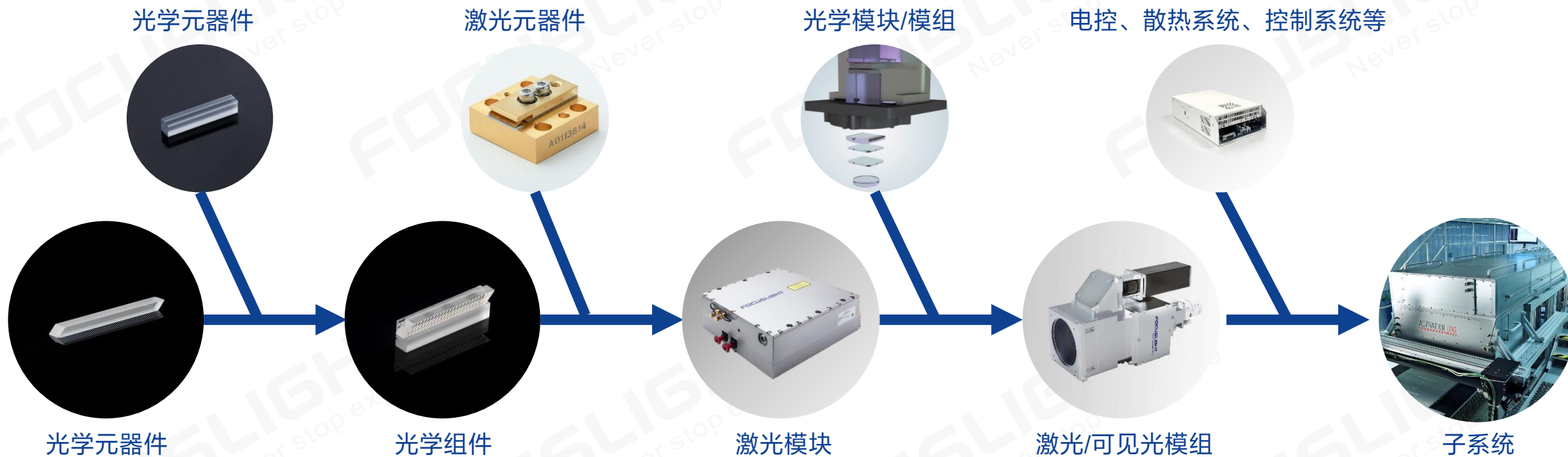

# 核心竞争力

知识产权

01

公司累计申请专利超过**1000**项

02

有效授权专利超过**610**项

03

7项软件著作

04

境内、境外有效商标合计超过**260**项



# 核心竞争力

国家标准

主持制定两项半导体激光器国家标准，  
已于2015年8月1日实施



标准号：GB/T 31359-2015

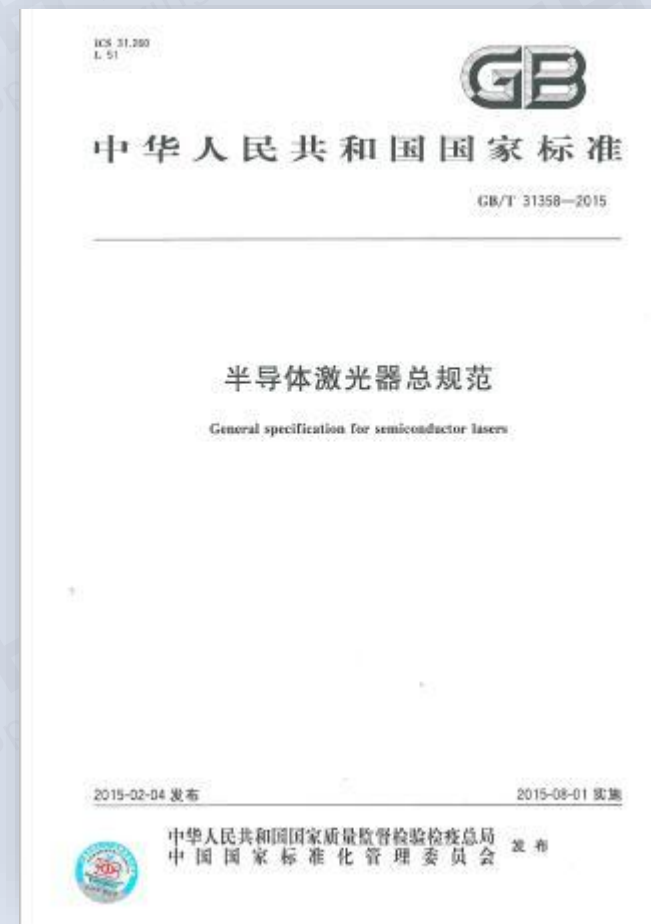

标准号：GB/T 31358-2015



# 核心竞争力

## 质量管控

ISO9001 质量管理体系认证

ISO14001 环境管理体系认证

IATF16949 汽车质量管理体系认证

ISO45001 职业健康安全管理体系认证

潜在失效模式与后果分析 (FMEA)

统计过程控制 (SPC)

生产可追溯系统

控制计划 (CP)



# 核心竞争力

## 质量管控

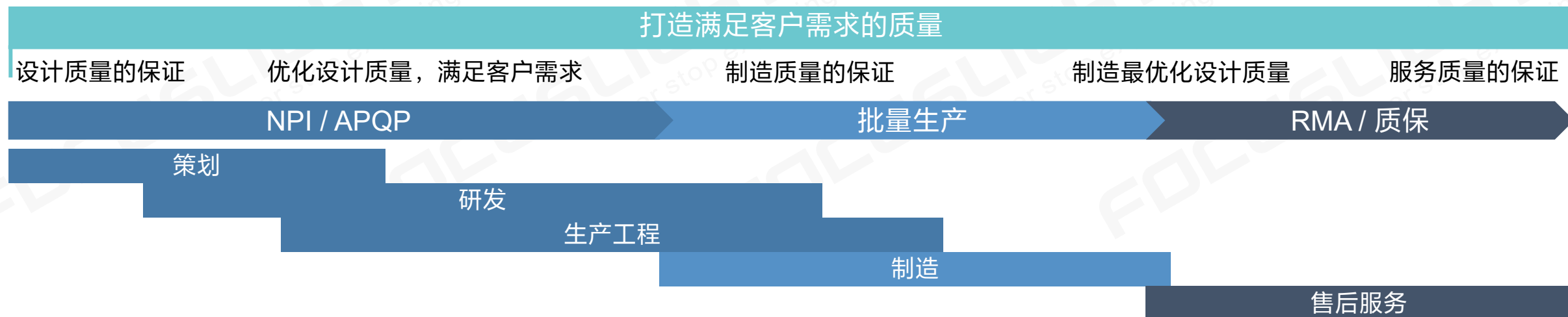

持续推进质量保证活动			
质量控制：设计系统	质量控制：制造系统		质量控制：评估系统
<ul style="list-style-type: none"> <li>质量功能展开</li> <li>关键特性，特殊特性</li> <li>公差链设计</li> <li>FMEA, FTA</li> <li>设计验证</li> <li>设计评审</li> </ul>	<ul style="list-style-type: none"> <li>参数设计</li> <li>过程FMEA</li> <li>工艺能力研究</li> <li>自动检验</li> <li>防呆/防错</li> <li>测量系统分析</li> </ul>	<ul style="list-style-type: none"> <li>QA网络</li> <li>供应商质量管理</li> <li>生产验证</li> <li>控制计划</li> <li>品管圈 (QCC)</li> <li>生产件批准程序</li> </ul>	<ul style="list-style-type: none"> <li>品管诊断</li> <li>质量保证会议</li> <li>质量审核改进会议</li> </ul>

# 核心竞争力

质量管控

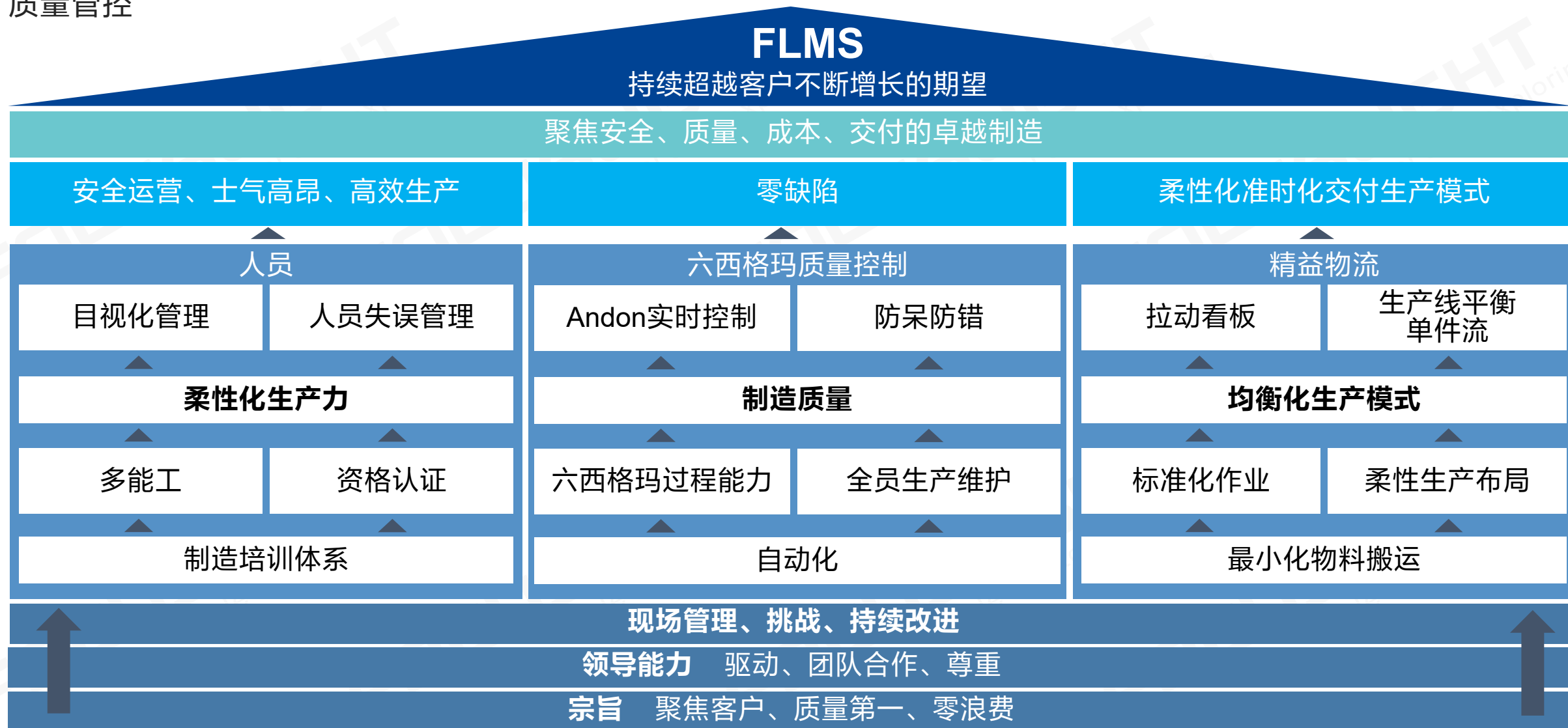

# 生产能力

## 卓越制造

- 以**卓越制造理念**引领公司各类产品的生产制造体系
- 对客户需求的高关注、对浪费行为的零容忍、对持续性改进的不断提高，配合先进的生产管理工具和自动化设备，达到**高效率、高质量、低成本**。
- 与全球汽车一级供应商合作的激光雷达发射模组项目已成功**进入量产**。
- 已通过 **IATF 16949** 认证和德国汽车工业协会 **VDA 6.3** 过程审核。





# 生产能力

半导体激光原材料

薄膜金属化工工艺领域多年经验积淀 + 自有核心工艺技术

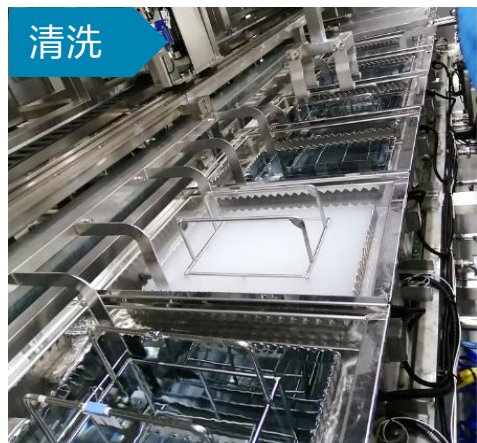

先进材料产能 > 200万只/月



# 生产能力

## 半导体激光元器件

封装与组装



光学组装



测量与测试



质量检验



老化与寿命测试



半导体激光器核心元器件产能 > 50万只/年，老化能力 > 60万只/年

# 生产能力

## 激光光学元器件 – 晶圆级同步结构化激光光学制造

晶圆生产

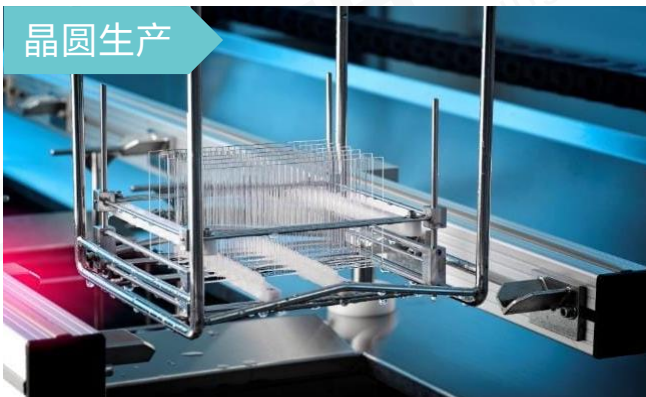

晶圆质量检验

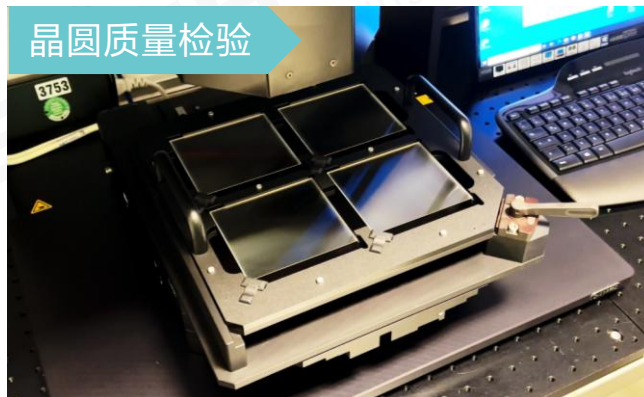

镀膜



激光切割

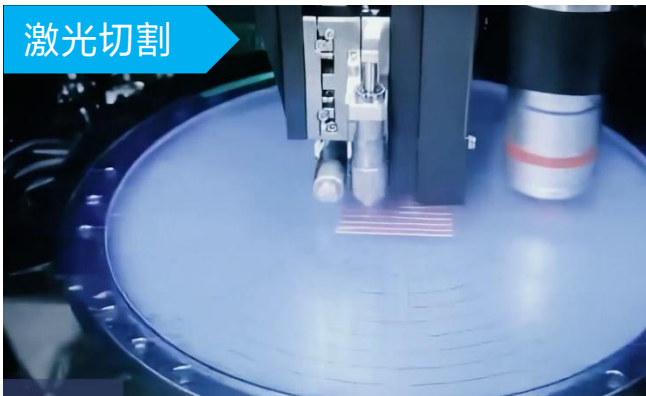

自动拾取

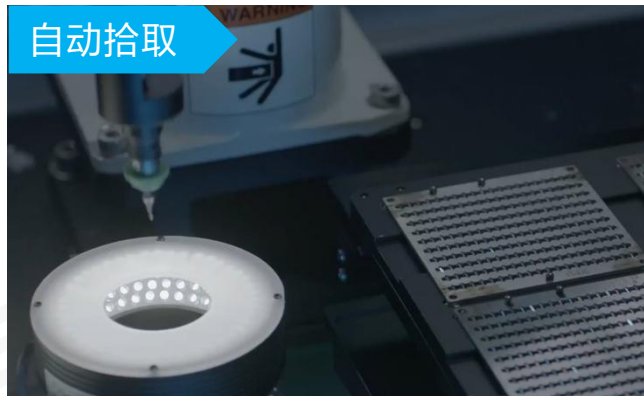

自动包装



晶圆级同步结构化激光光学制造：  
产能 > 2000片晶圆/月，或 > 350万只光学元器件/月



# 生产能力

激光光学元器件 – 光刻-反应离子蚀刻法晶圆级微纳光学精密加工制造

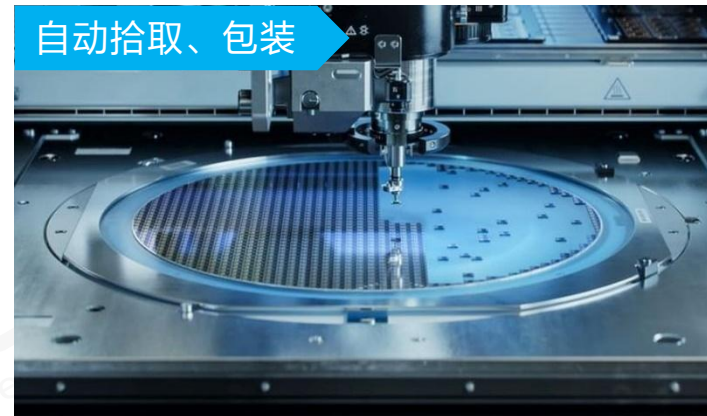
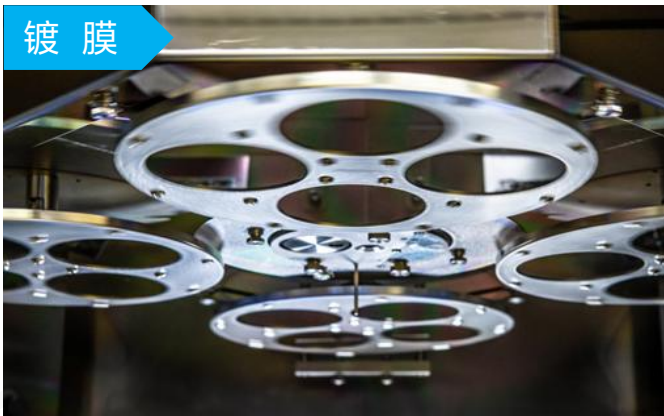
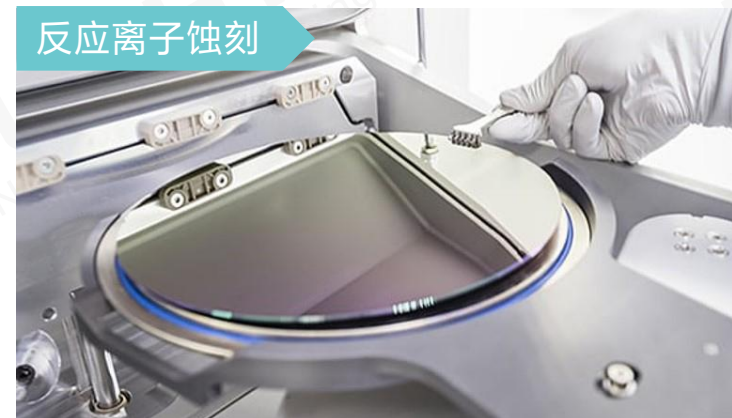
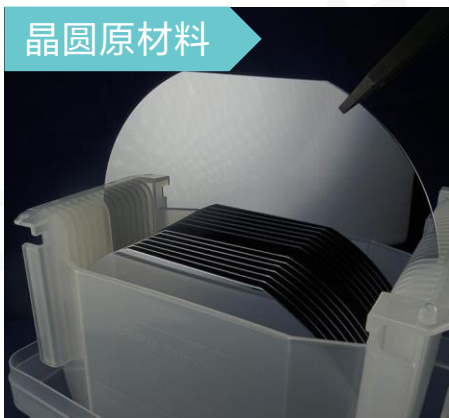

光刻-反应离子蚀刻法晶圆级微纳光学精密加工制造：  
产能 > 300片晶圆/月



# 生产能力

激光光学元器件 – 压印精密微纳光学加工制造

母版制作

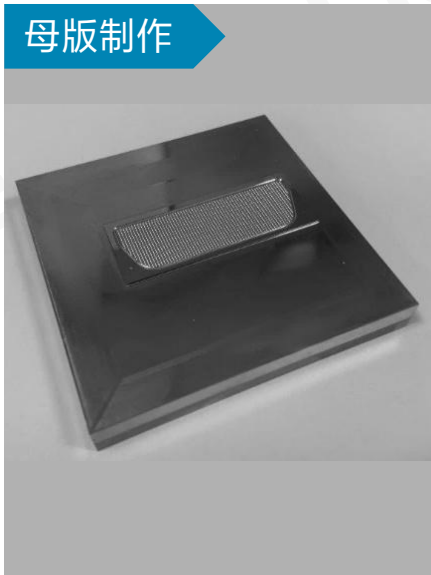

压模

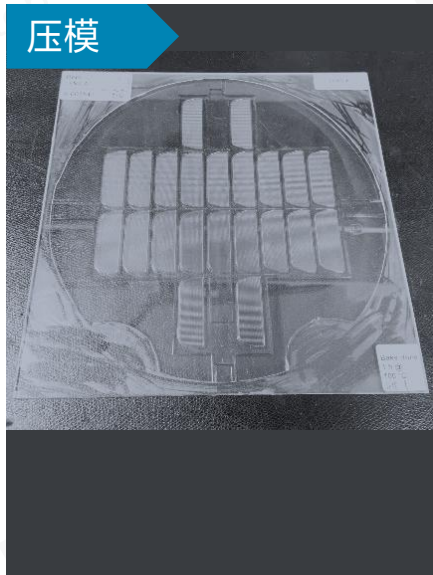

压印



测试



切割



压印精密微纳光学加工制造：  
产能 > 1.5万片晶圆/年，或 > 3000万只光学元器件/年

光学工艺自动化

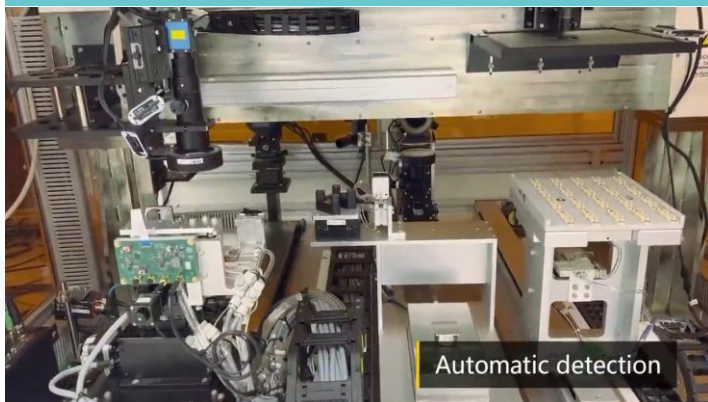

组装工艺自动化

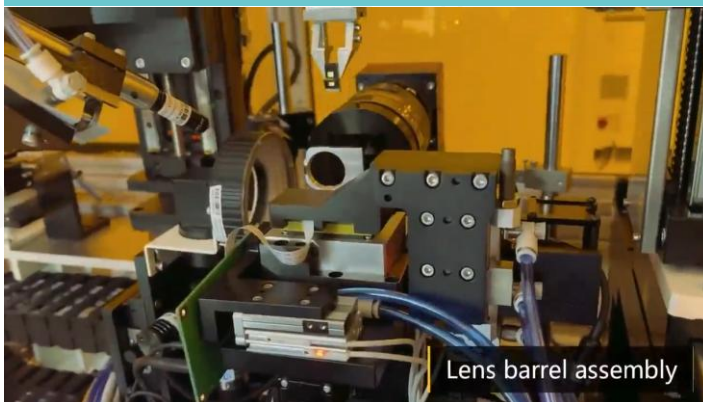

光学检测自动化



激光光学生产产线



激光雷达发射端模组生产产线





# 典型产品

半导体激光元器件及原材料

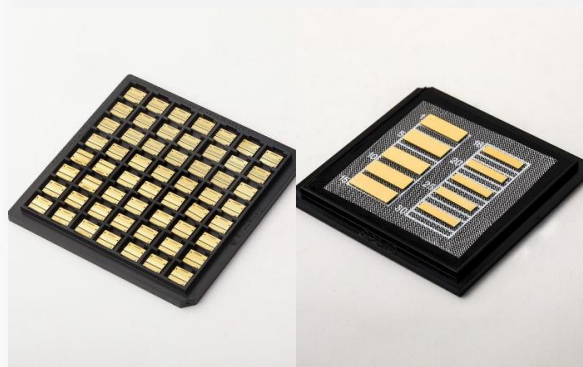

## 先进材料

- 预制金锡氮化铝衬底
- 预制金锡铜钨衬底
- 薄膜金属化服务



## 有源器件

- 单管激光器
- 单巴激光器
- 微通道冷却叠阵
- 传导冷却叠阵
- 泵浦模块



## 光纤耦合模块

- 单管/多单管光纤耦合模块
- 巴条耦合模块

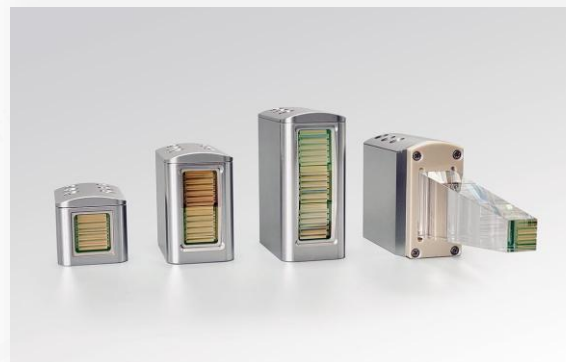

## 专业医疗健康应用元器件

- 激光净肤模块

# 典型产品

激光光学元器件

## 单透镜与一维透镜阵列



快轴准直镜 (FAC)



慢轴准直镜 (SAC)

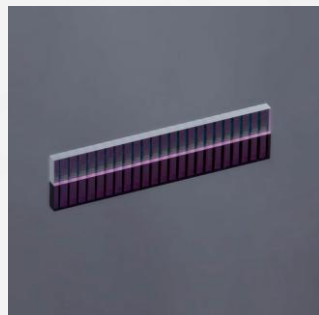

慢轴准直阵列



光束转换器 (BTS)

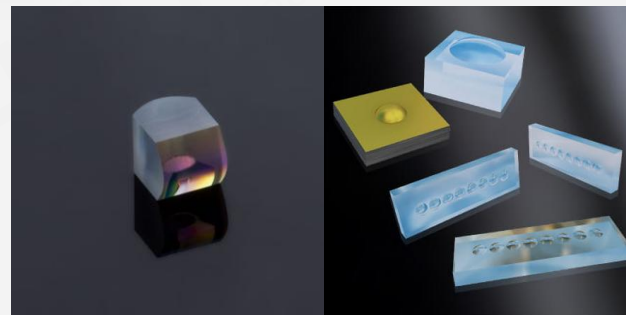

光纤耦合器与准直器

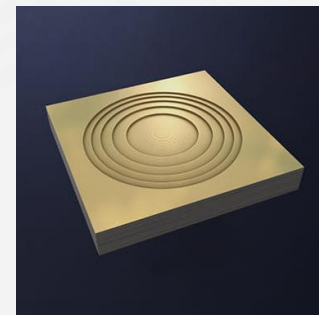

衍射准直透镜

## 二维面阵透镜阵列



光场匀化器、  
光束扩散器

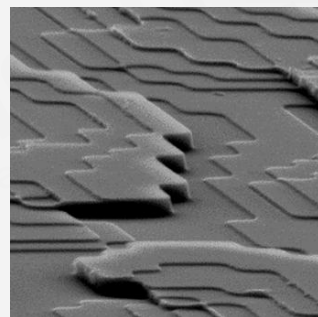

衍射分束器、点/线  
生成器



夏克-哈特曼阵列

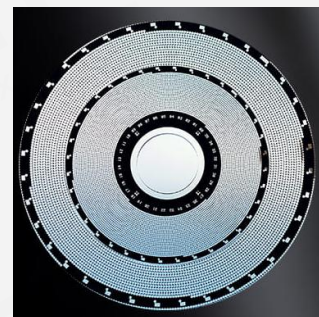

针孔透镜阵列

## 平面光学与镀膜

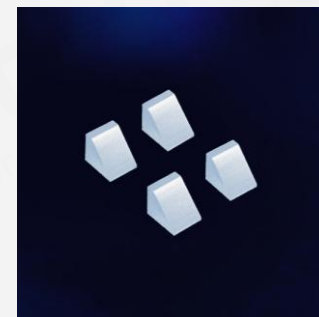

微棱镜

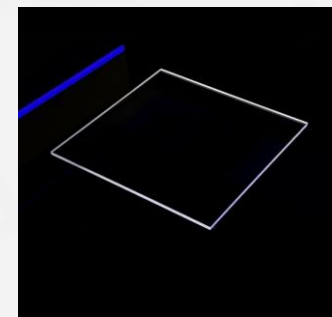

窗口片



# 典型产品

汽车应用解决方案

## 全固态激光雷达发射端模组

AX02 Pro (样件)



VCSEL 面光源发射模组 700W

## 混合固态激光雷达发射端模组

LE02 Pro (样件)



905nm 700W EEL 线光源发射模组

LX02 (样件)

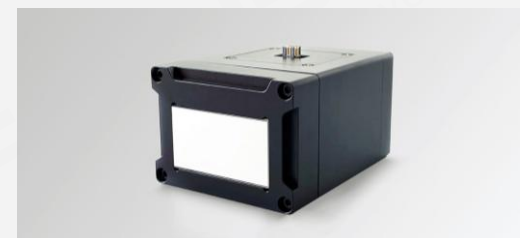

千瓦级 VCSEL 线光源发射模组

## 光学元器件及光束整形解决方案

EEL FAC 准直镜

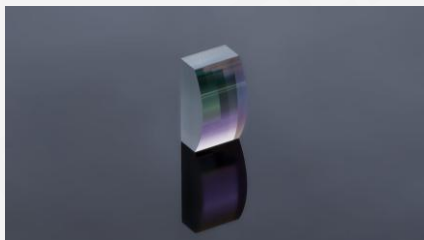

车规级光场匀化器及  
光束匀化扩散器



汽车投影照明与汽车前照大灯用光学元器件

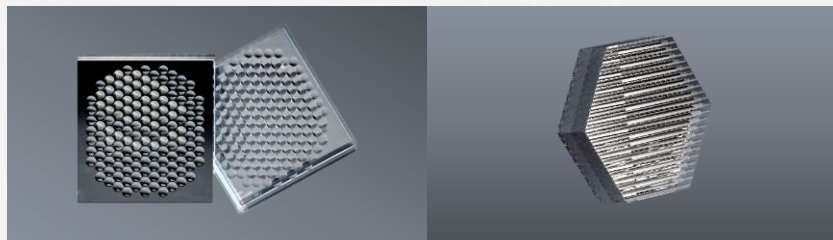

定制化设计光学组件



# 典型产品

## 泛半导体制程解决方案

### 先进显示制程解决方案



固体激光剥离紫外激光线光斑系统



固体激光退火紫外激光线光斑系统



可变光斑激光系统 (Mini 和 Micro LED制程)

### 半导体集成电路制程解决方案

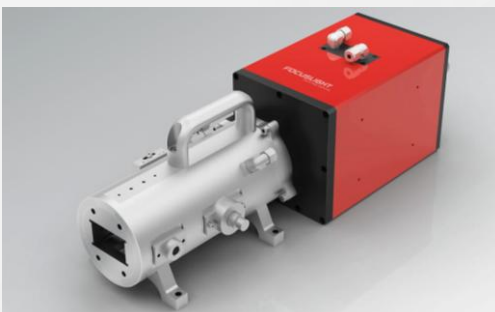

集成电路晶圆退火系统



可变光斑激光系统 (芯片先进封装)

### 工业应用解决方案



红外激光线光斑系统



工业激光模块

# 典型产品

医疗健康解决方案

激光净肤模块



激光嫩肤模块



激光无创溶脂模块



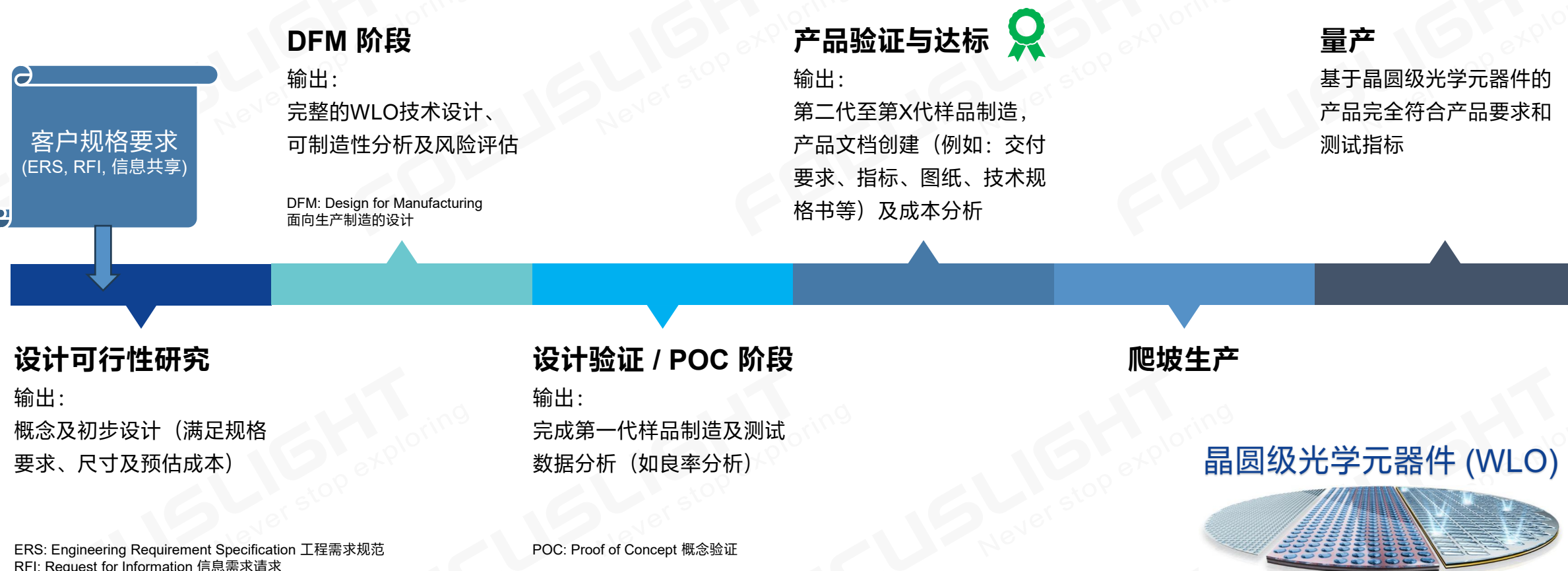

与我们合作 – 从前期概念到大批量生产

 **HEPTAGON**  
A FOCUSLIGHT BRAND



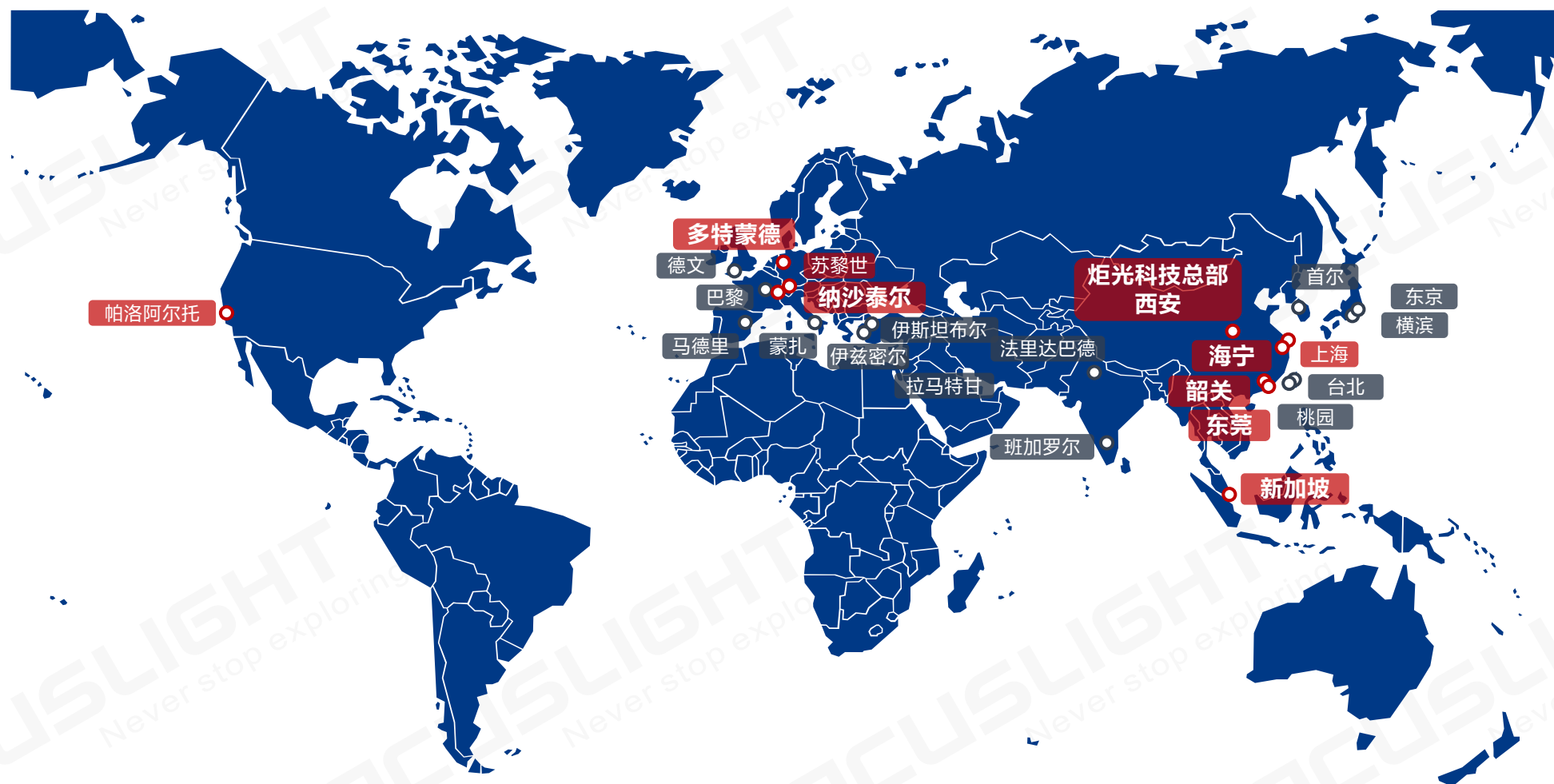

- 经销商遍布世界各地，销售额近50%来自海外，包括美国、德国、意大利、以色列、日本、韩国等
- 销售办公室位于中国、瑞士、美国
- 生产研发中心位于西安、多特蒙德、东莞、海宁、韶关、纳沙泰尔、新加坡

# 资质荣誉

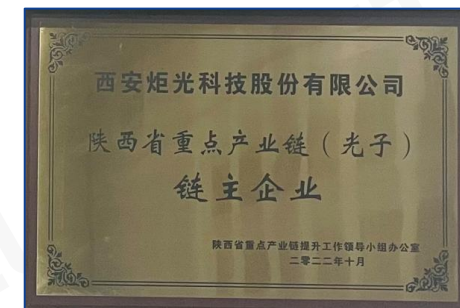
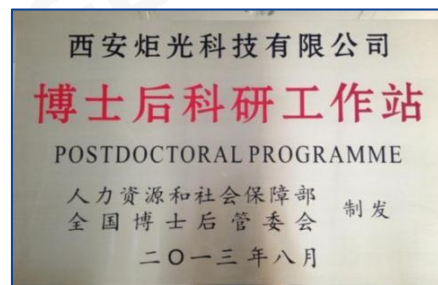
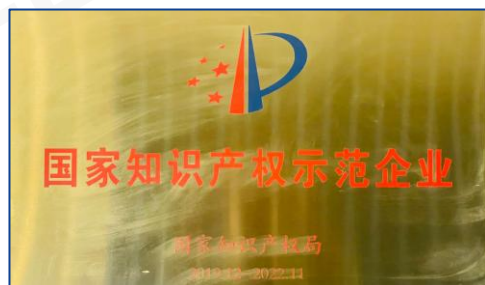
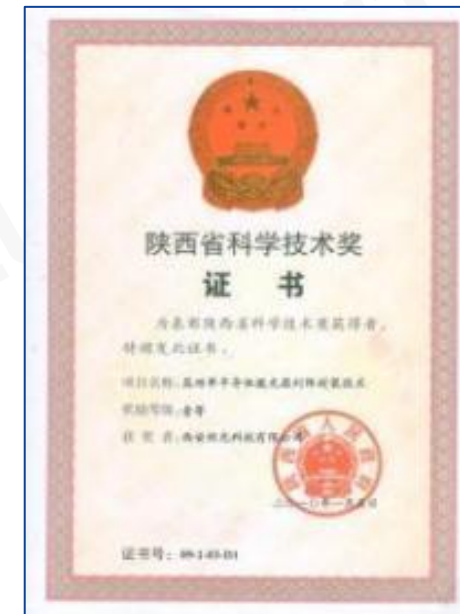
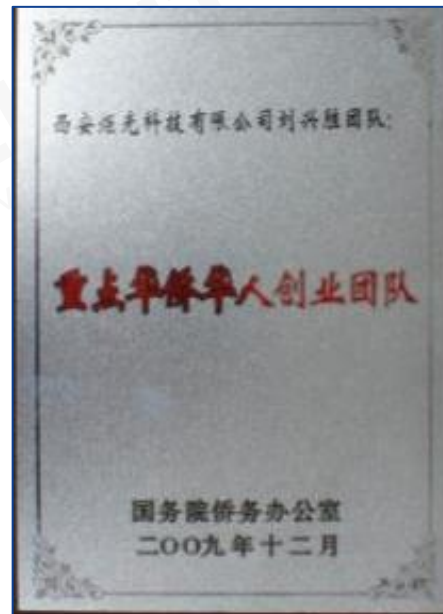
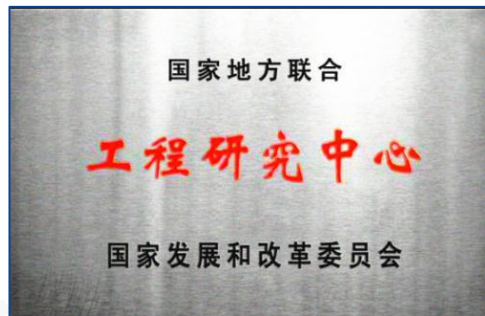





◀ 2015年6月3日

CCTV1《新闻联播》在“领航科技 创新中国”系列报道中以《刘兴胜：给激光器安上中国“心”》为题，对炬光科技进行了专题报道。（全国18位科技领域典型人物）



◀ 2017年9月23日

中央电视台CCTV13《新闻直播间》在“至诚报国”系列报道中以《刘兴胜：中国创造的激光器走向世界》为题，对炬光科技进行了专题报道。







2010年6月  
赵乐际莅临公司调研



2010年10月  
李克强莅临炬光科技考察

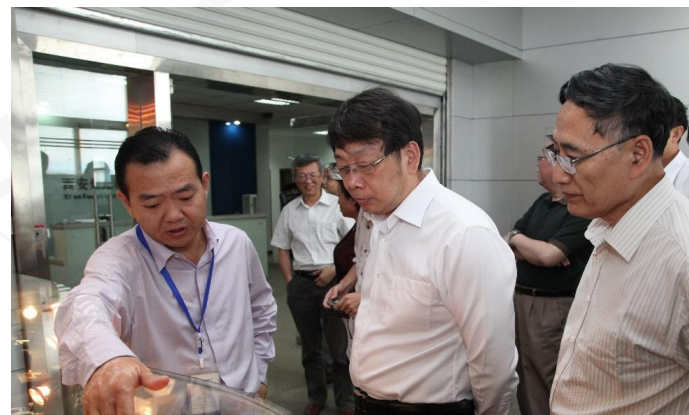

2012年6月  
陈希莅临炬光考察指导工作

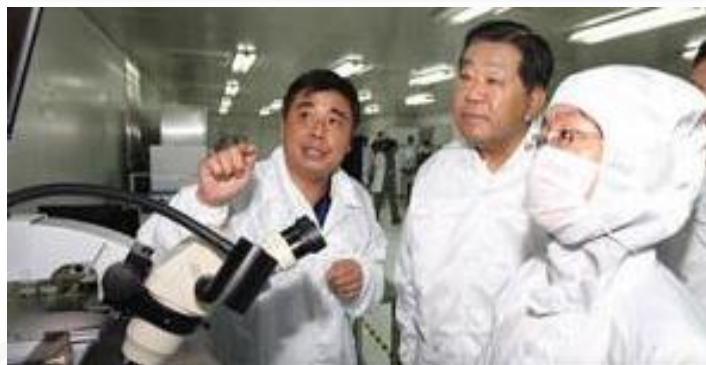

2011年8月  
贾庆林莅临炬光科技进行工作调研



2013年4月  
王勇莅临炬光科技



2016年4月  
孙春兰莅临炬光科技

## 光子技术元器件及解决方案，优质可靠的长期合作伙伴



半导体激光光源领导者及优秀的光束整形专家



微纳光学器件一站式提供商，五种光学制造技术为客户需求提供最佳选择



全球光子工艺和制造服务将客户的创意和设计转化为其自身产品和解决方案



整体解决方案、定制化服务和优秀的现场服务支持



强大的研发能力，大批量生产制造能力，优质可靠，低成本



财务状况良好，来自投资者的有力支持，实现长期增长

# THANK YOU



[www.focuslight.com](http://www.focuslight.com)

[www.hptg.com](http://www.hptg.com)

