

Focuslight Corporate Overview

© Focuslight Technologies Inc.

2026-06

Focuslight Overview

- Founded in 2007 by Dr. Victor X. Liu, headquartered in Xi'an, China.
- A fast-growing company that develops and manufactures:
 - **Laser sources and materials** (Photon Generation)
 - **Optical components** (Photon Control)
 - **Photonics module and system solutions** (Application Solutions) focusing on **optical communication, consumer electronics, and pan-semiconductor applications.**
- A **global photonics foundry** offering process development and manufacturing services to the global photonics community.
- Publicly listed in the Shanghai Stock Exchange (Ticker Symbol: 688167).



Milestones



2007

Founding of Focuslight



2018

Dongguan delivery and high-volume manufacturing center officially in operation



LIMO

Lissotschenko Mikrooptik

2017

Acquisition of LIMO;
Started providing photon control and photonics application solutions

IPO

2021

Successful IPO at Shanghai Stock Market

FOCUSLIGHT
Never stop exploring

2019

Global branding identity upgrade



HEPTAGON

2024

Acquisition of ams OSRAM's optical component assets;
Relaunch of Heptagon brand

SUSS MicroOptics

2024

Acquisition of SUSS MicroOptics



2024

Shaoguan Base officially in operation

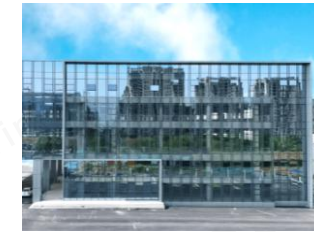

2025

Hefei Base officially in operation

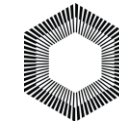

BRIGHTVIEW
TECHNOLOGIES

2026

Announced strategic partnership with BrightView

Focuslight Corporate and Subsidiaries

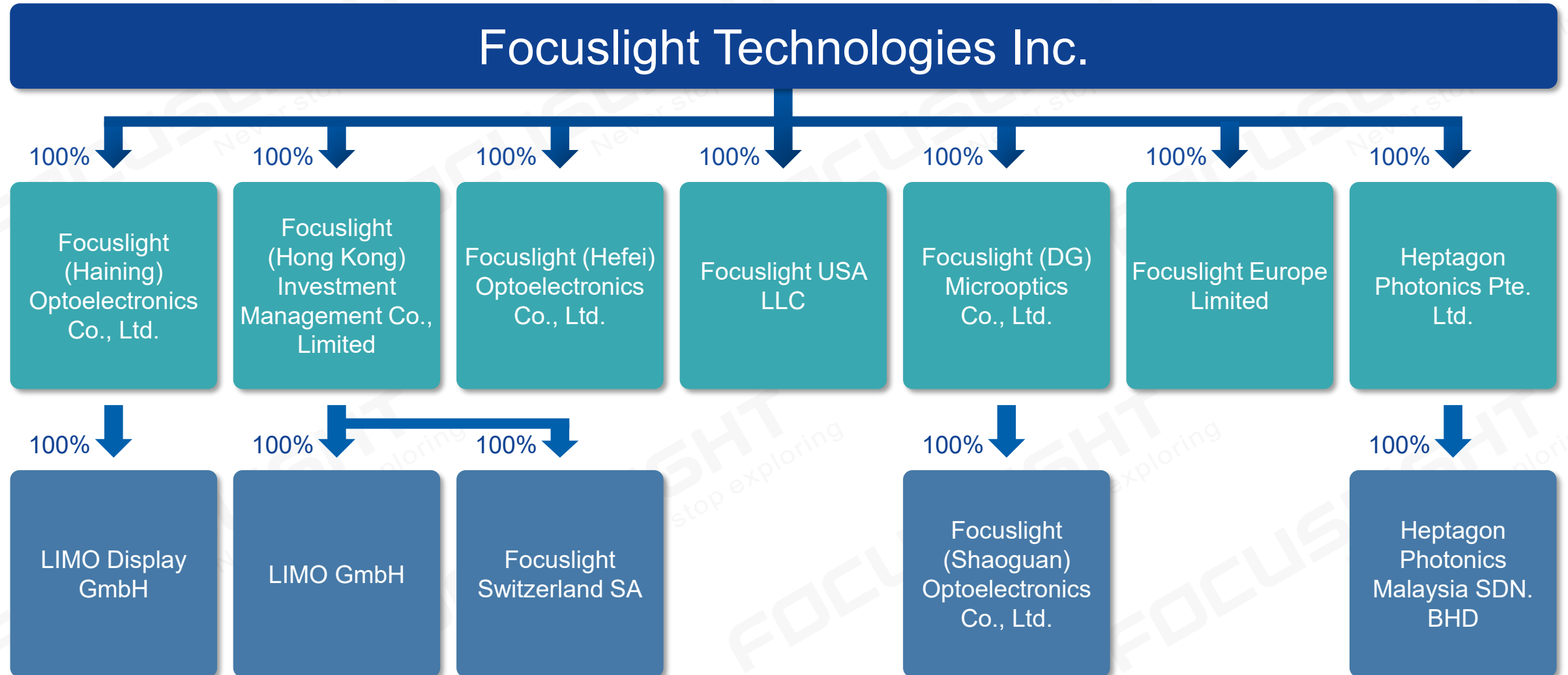

Focuslight Global Operations System

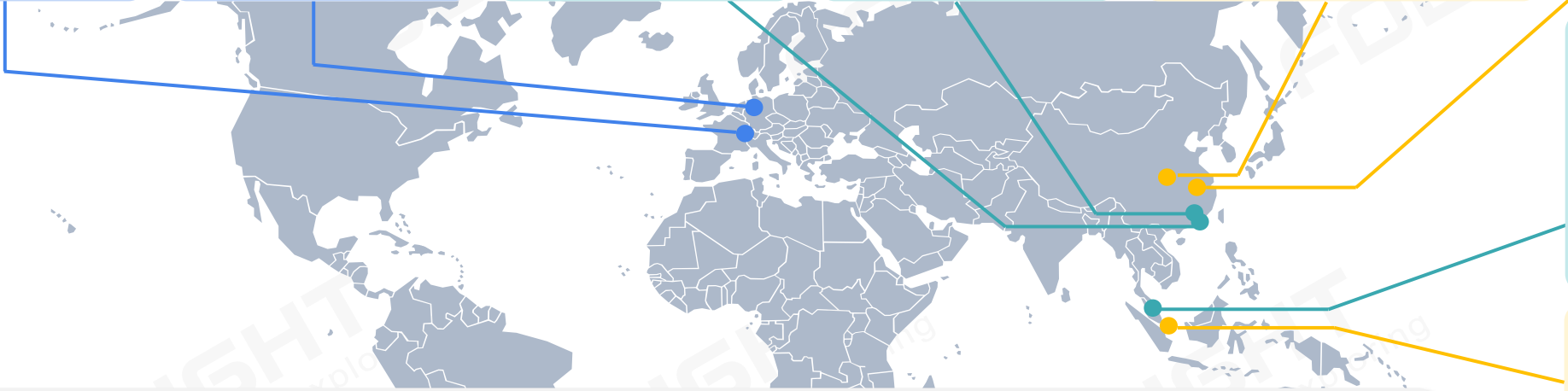
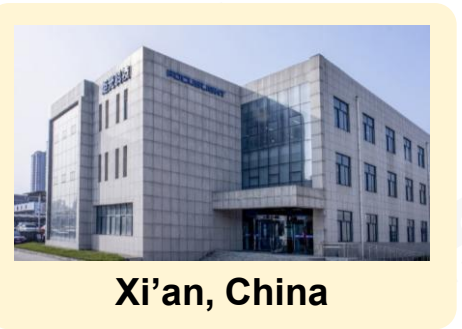
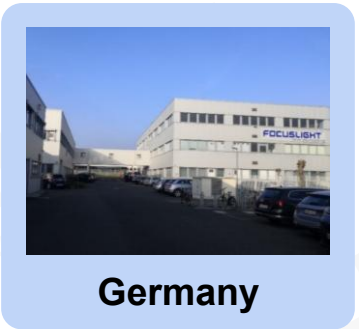

Fast Development Cycle: Europe/China co-innovation → Singapore/China engineering → China/South Asia mass production

Cost & Quality: Competitive production cost without compromising precision or reliability

Supply Chain Resilience: Multi-site operations reduce geopolitical and single-location risks

Customer Proximity: Localized fast response across China, USA, Europe, and Southeast Asia

Key Facts & Figures



Employees

>900



Revenue Proportion Invested
into R&D (2025)

~20%



Yearly Revenue
(2025)

880M RMB



Patents Valid
Worldwide

>510



Facility Worldwide

>49,000m²

Clean Room Worldwide

>17,000m²































ISO 9001
ISO 14001
ISO 45001
IATF 16949
Certified

Corporate Management Team

 <p>Dr. Xingsheng Liu (Victor) Chairman, CEO</p> <p>Research and management experience in the US, with 100+ publications, 300+ patents, 30+ invited papers internationally</p> <p>Committee Member of SPIE and IEEE</p> <p>CORNING COHERENT nLIGHT</p>	 <p>Dr. Chung-En Zah CTO</p> <p>30+ years of research experience in the US, with 300+ publications, 50+ patents in optoelectronics and telecommunication</p> <p>IEEE Fellow, OSA Fellow, 2x R&D 100 award winner</p> <p>THORLABS CORNING Bellcore <small>© Bell Communications Research</small></p>	 <p>Mr. Sinclair Vass Corporate SVP of International Sales & Business Development</p> <p>35+ years experience in international photonics markets, having held technical, commercial and general management leadership roles at major multinational companies</p> <p>Velodyne JDSU Lucent Technologies <small>Bell Labs Innovations</small> </p>
 <p>Mr. Tan Chee Huo (Michael) Corporate SVP of Business Process and IT</p> <p>25+ years in IT leadership, specializes in digital business transformation, global project management, multicultural team leadership in fast-paced international industries, and strategic decision-making</p> <p>NOKIA ThermoFisher <small>SCIENTIFIC</small> Tupperware EVIDENT</p>	 <p>Mr. Guowei Zhu (Gavin) Vice President of Global Operations</p> <p>20+ years in international automotive companies, rich experience in IATF QMS and plant operations management by World Class Manufacturing (WCM) & Lean manufacturing</p> <p>MAGNETI MARELLI BorgWarner GST <small>SEITON AUTOLEATHER</small></p>	 <p>Mr. Lucas Zhang Vice President of Global Operations</p> <p>20 years of global supply chain management experience at multiple Fortune 500 companies, with strong expertise in supply chain planning and management within the consumer electronics industry</p> <p>HUAWEI LCFC </p>
 <p>Mr. Ye Dai (Robert) Corporate VP of Global Sales</p> <p>Excellent track record in worldwide sales, product line and business unit management leadership roles</p> <p>20+ patents granted</p> <p>IVO APPLIED MATERIALS</p>	 <p>Ms. Yiping Ye (Alison) Board Director, CFO</p> <p>Over 20 years management experience and multi-field business practices</p> <p>In-depth understanding in LTC, IPD, intercultural cooperation and rich operational experience in market development, project operation and business management</p> <p>HUAWEI Hanergy <small>汉能</small></p>	 <p>Mr. Qichuan Yu Chief Product/Process Officer</p> <p>Over 25 years of experience in wafer-level optics, optical sensor and camera packaging, SAW/BAW filter R&D, and NPD execution, with a strong focus on mastering, tooling, and wafer-level processes</p> <p>amun OSRAM HEPTAGON EPCOS</p>

Corporate Management Team

	<p>Ms. Xuefeng Zhang (Jennifer) Board Director, Board Secretary, Marketing Director</p> <p>Over 15 years photonics industry international business experience, in-depth understanding and rich experience in sales, marketing and business development</p>  		<p>Mr. Hong Wang Corporate R&D Director</p> <p>PhD in physics and Master in computer science. 20+ years in quantitative analytics, capital market risk modeling and architecting. Expert in building analytic infrastructure and system. Rich experience in multinational team management.</p>   
	<p>Mr. Dirk Walter Bogs Corporate VP, President of Laser Optics BU</p> <p>Over 25 years' experience in ultra-precision tooling, optic manufacturing, engineering & project management, and operational management Very deep knowledge of technology development and optimization</p> 		<p>Mr. Yong Tian (York) Corporate VP, VP of Laser Optics BU</p> <p>20+ years of operation & R&D management, very deep knowledge with organic optical materials and optical coating technology, published SCI articles and owns patented technologies. Experienced in Lean Manufacturing & Industry 4.0</p>  
	<p>Mr. Weiyi Gu President of Laser Source and Applications BU</p> <p>13 years experience in photonics R&D and product management, with rich track records of leaderships in developing and delivering system solutions for pan-semiconductor and industrial applications</p> 		<p>Mr. Vicknes Ratha Krishnan VP of Laser Source and Applications BU</p> <p>Proven business leader, 16+ years in program and product management within optoelectronics and semiconductors, working with multinational companies and top-tier customers.</p>    
	<p>Mr. Hongyuan Liu (Tom) President of Global Photonics Foundry BU</p> <p>20+ years in R&D and operations management, specializing in optical imaging and non-imaging system design, WLO process & integration, and optical component manufacturing. Proven track record in new product development and scaling high-volume production</p>    		<p>Dr. Tobias Senn Head of Strategic Growth R&D</p> <p>15+ years of experience in micro-optical component development for the consumer market. Expert in design for manufacturing and process development, with a strong focus on high-volume production and yield improvement</p>    

Business and Branding

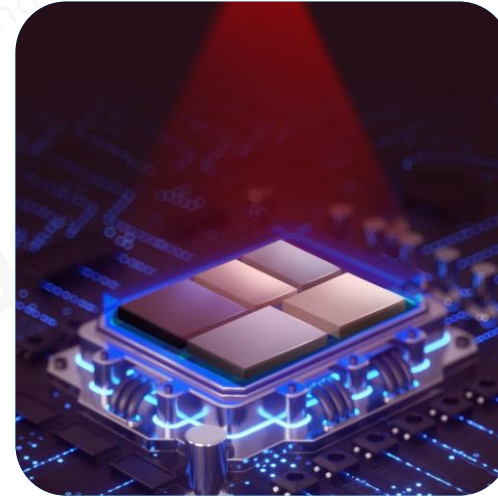
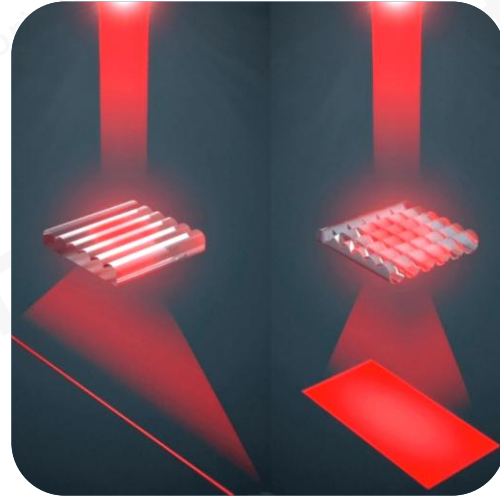
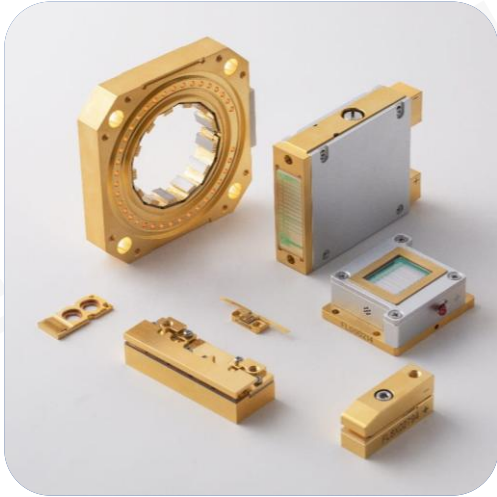

Photon
Generation



Photon
Control



Photonics
Application
Solutions



Global
Photonics
Foundry

FOCUSLIGHT
Never stop exploring



 **HEPTAGON**

Markets

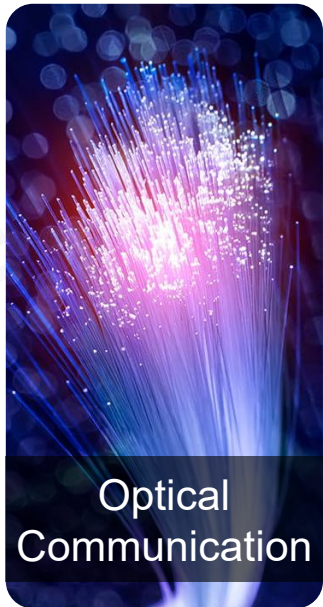

16%
revenue

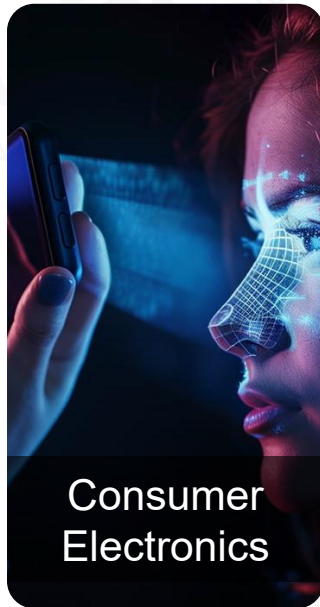

9%
revenue

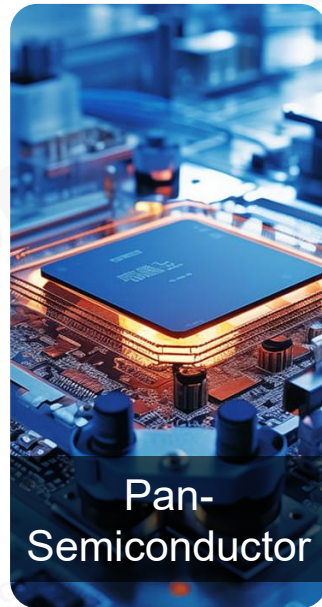

22%
revenue



18%
revenue



11%
revenue



24%
revenue

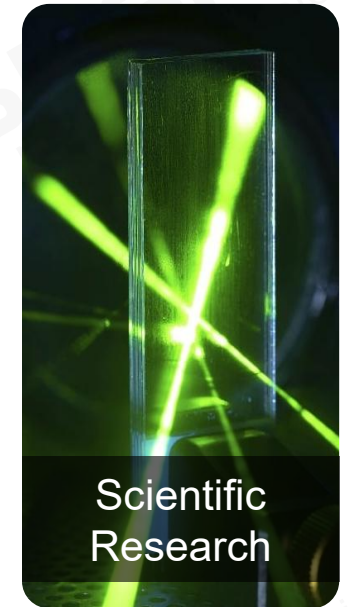



1%
revenue



** Based on accumulated revenue data from 2026 Q1 with rounded figures*

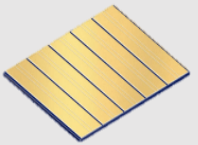

Value Proposition



Total Solution and Service in Full Value Chain

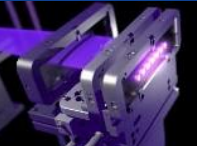

	Chips (Strategic collaboration with Suppliers)
	Packaging Materials
	Optics Substrate

	Light Sources
	Optical Components
	Fiber Coupled Modules

	Laser Subsystems
	Optical Subsystems
	Integrated Modules

	Application Centers
	Technical Support
	Field Service Centers

Industry Leader + Strong Financial Backing + Healthy Stable Company + Invest in the Future



Do what we do best

Offer the best value

Optimize to the extreme

Achieve the best
performance / quality-to-
price ratio

Commitment to Customers

- Lowest cost manufacturing for high volume products
- Willing to take technical risk, but request customer commit market share in return
- Willing to take investment risk in R&D and capital including M&A for customer but request customer commit market share in return
- Collaboration transparency, fast response, IP protection and long-term partnership



What we don't do

Take high market risk

Be greedy

Be too aggressive

Compete against our
customers

Vision

To unlock the potential of photonics to enhance and enrich people's life



Mission

Be the global trusted photonics solution provider through innovation, operational excellence and fast response

Products and Services

Micro-Optics

Single Lenses and Linear Lens Arrays



FAC



SAC

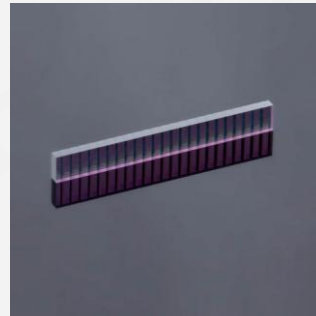

SAC array



BTS



Fiber coupler and collimator

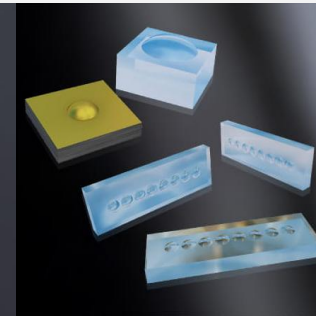

Collimating DOE

Area Lens Arrays



Homogenizer and diffuser

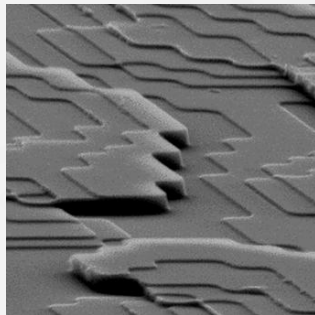

DOE beam splitter, dot or line generator



Shack-Hartmann array

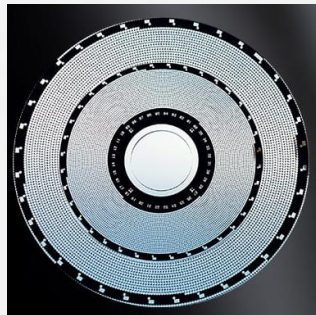

Pinhole array

Plano Optics and Coatings

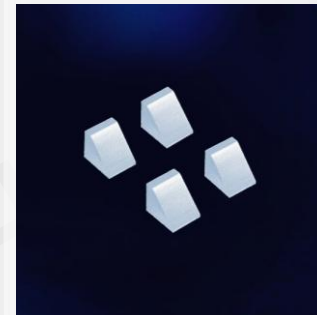

Micro prism

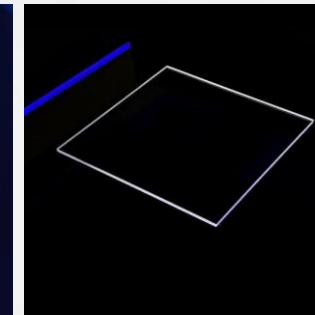

Window

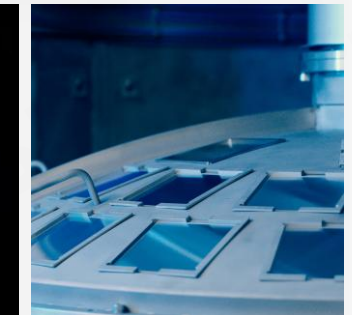

Optical Coating

Products and Services

Laser Sources and Materials

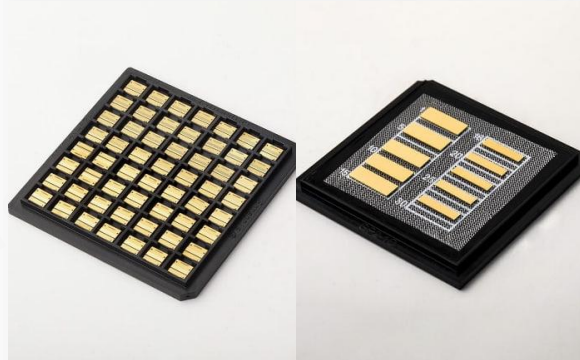

Advanced Materials

- AuSn Pre-Deposited AlN Submounts
- AuSn Pre-Deposited CuW Submounts



Open-Package Diode Lasers

- Single Emitter Components
- Single Bar Components
- Micro-Channel Cooled Stacks
- Conduction Cooled Stacks
- Pumped Modules



Fiber-Coupled Diode Lasers

- Emitter-Based Modules
- Bar-Based Modules

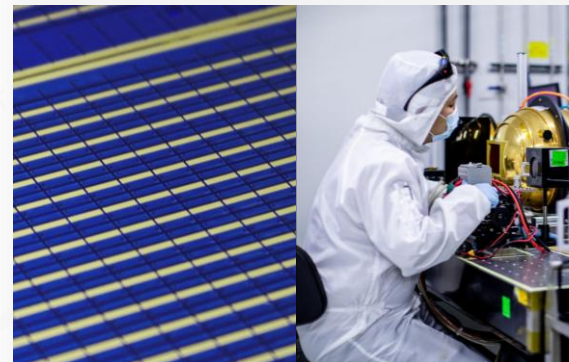

Technical Services

- Thin Film Metallization Service
- Diode Laser Manufacturing Service

Products and Services

Medical and Health Application Solutions

**Laser Hair Removal
Modules**



**Laser Skin
Rejuvenation
Modules**



**Laser Body
Sculpting Modules**



Diode Laser Drivers



Products and Services

Pan-Semiconductor Application Solutions

Advanced Display Manufacturing



Solid-State Laser Lift-Off (LLO) System



Solid-State Laser Annealing (SLA) System



Variable Beam Laser System
(Mini and Micro LED Processing)

IC Manufacturing

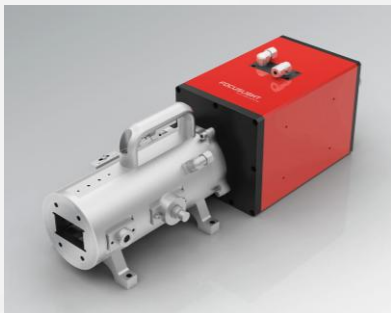

IC Wafer Annealing System



Variable Beam Laser System
(Advanced Chip Packaging)

Industrial Solutions



IR Line System

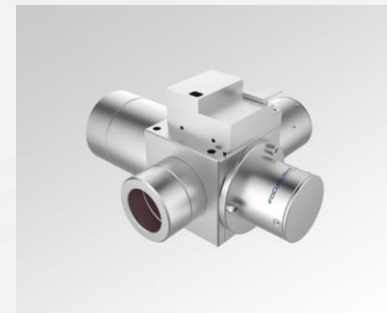

Industrial Laser Module

Technical Service



End-to-end Technical Services

Products and Services

Consumer Electronics Solutions



BRIGHTVIEW
TECHNOLOGIES

Beam Shaping and Pattern Generating

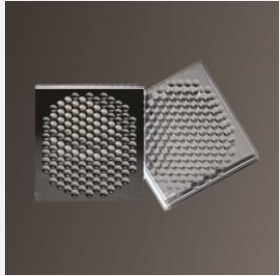

Pattern-Generating MLA

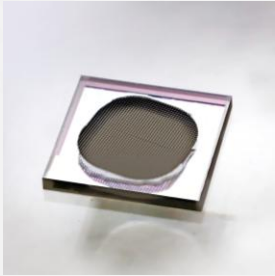

Engineered PoG Diffusers

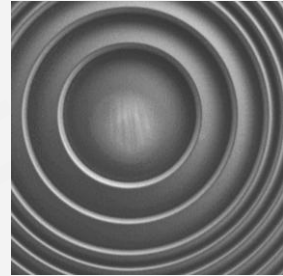

Diffractive Optical Element (DOE)

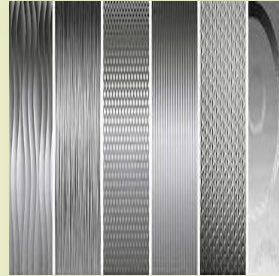

Diffusing and Hiding Films

Guide and Extraction

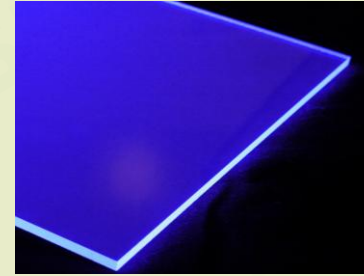

Light Guiding Films

Reflecting



Reflectivity Films

Imaging and Projection

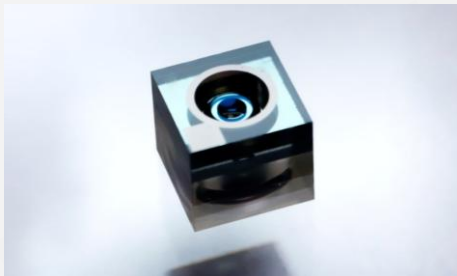

Imaging Lens Modules



Projection Lens Modules

3D Sensing



Sensing Modules

Semicon Foundry



Optical Component and Module Imprinting Service on Si Wafers

Products and Services

Automotive Application Solutions



Projected Lighting

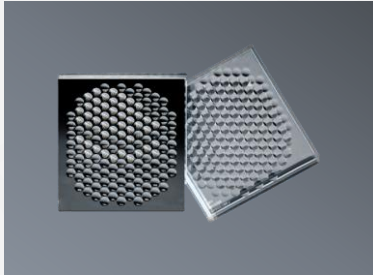

Micro lens Arrays for Projection



MLA-Based Dot Projectors

Smart Headlights

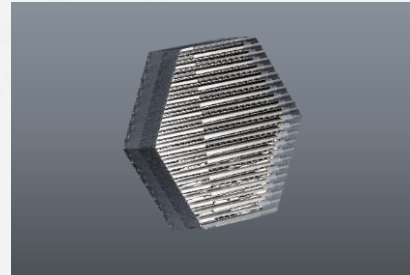

Micro lens Arrays

Interior/Exterior Lighting

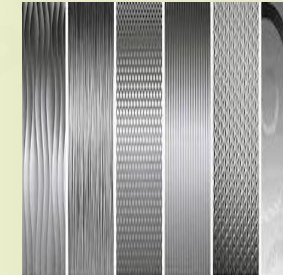

Homogenizing Films

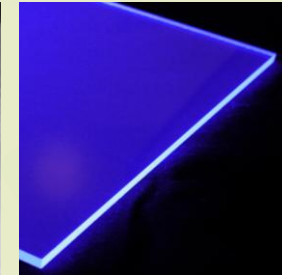

Brightness Enhancement Films



Reflecting Films

Driver Monitoring System

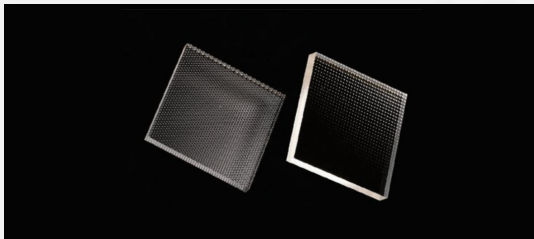

Homogenizers / Diffusers for Illuminators

LiDAR

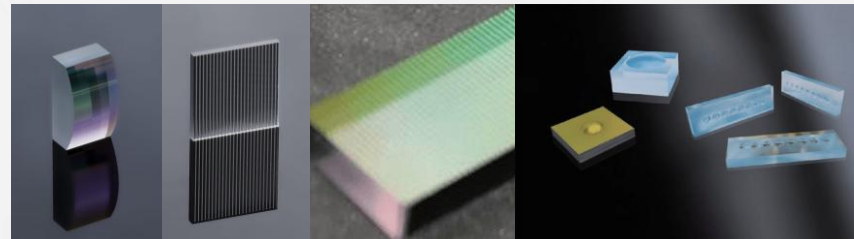

Beam Shaping Optics: Fast Axis Collimators, Diffusers, Homogenizers, Collimators and Arrays

AR HUD

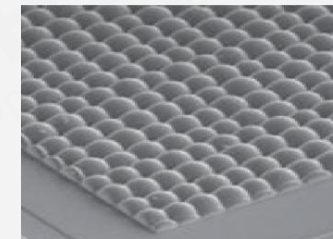

Homogenizers / Diffusers

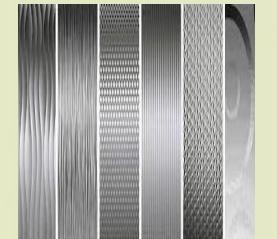

Homogenizing Films

Global Photonics Foundry Services

From Concept to Mass Production

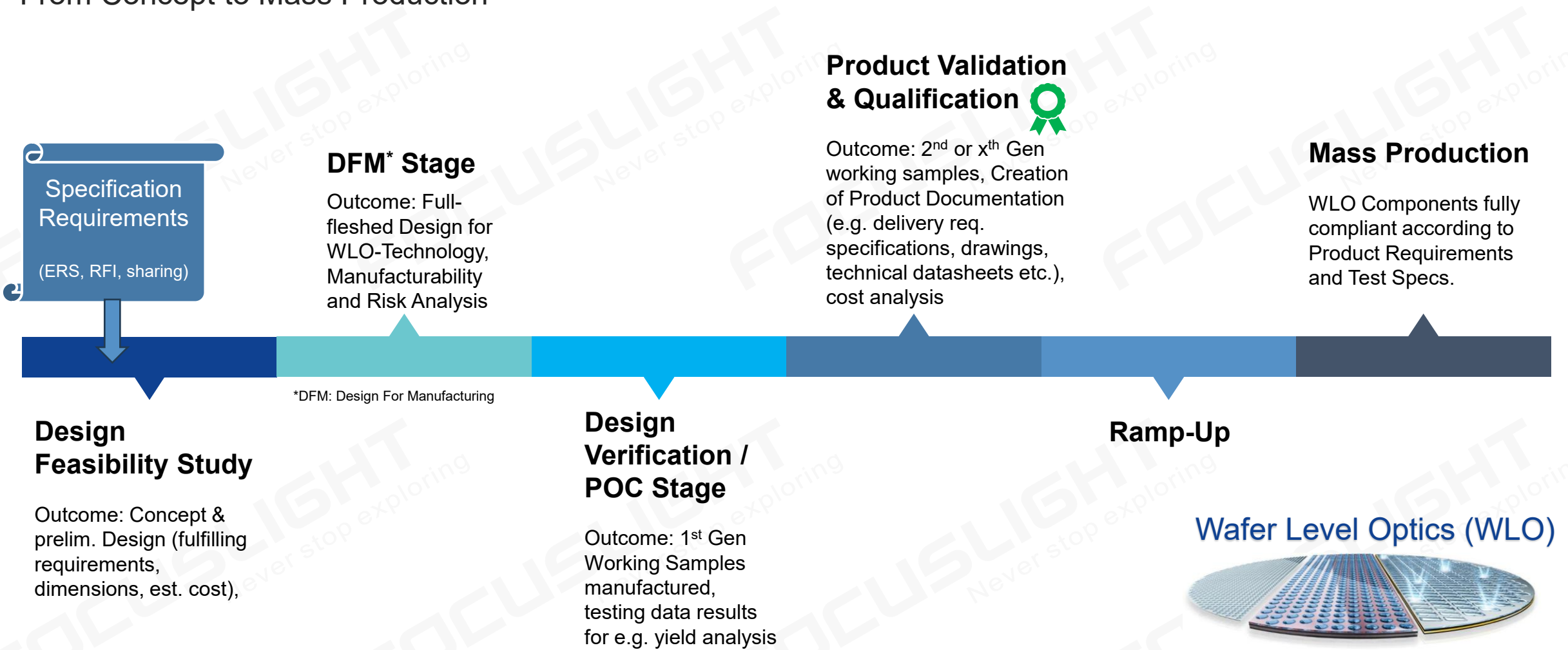

Core Competence

Diode Laser

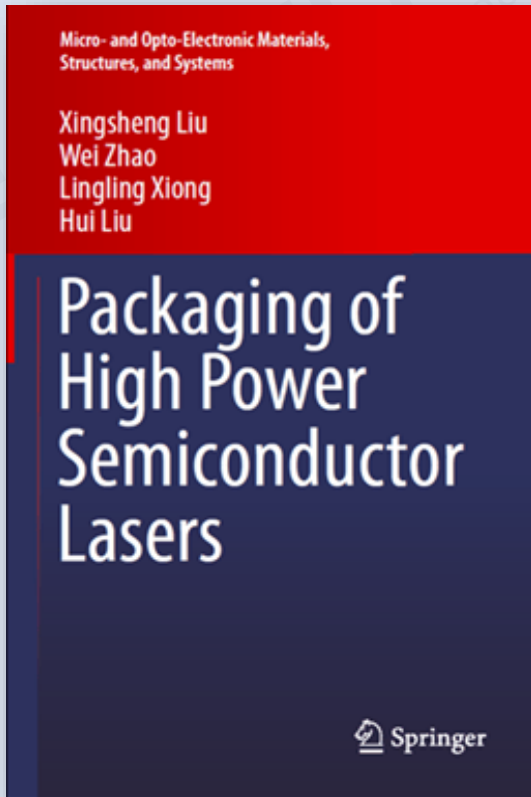

Eutectic Bonding

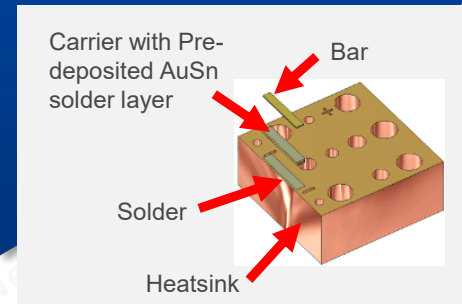

Significantly enhances thermal conductivity, reducing thermal stress, and thus improving the products' performance and lifetime

Thermal Management

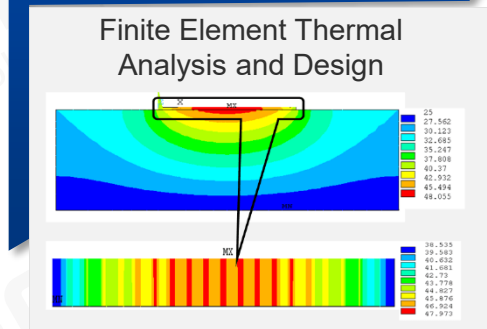

Effectively improves the ability of heat dissipation to ensure a higher output power

Thermal Stress Control

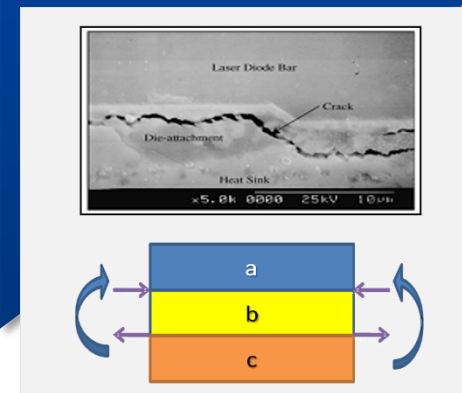

Lowers and homogenizes the thermal stress, and improve the device performance

Interface Materials and Surface Engineering

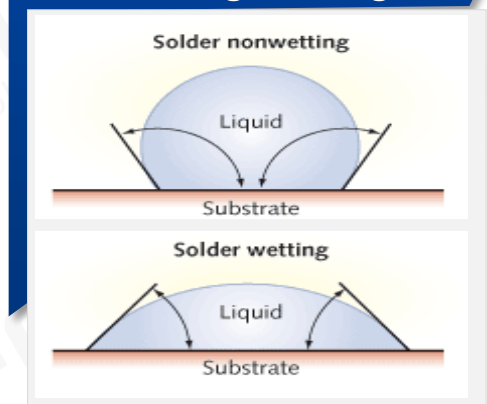

Greatly improves wettability and bonding strength of packaging materials, enhancing long-term reliability

Core Competence

Beam Shaping – *The Right Photon at the Right Place and Time!*

Micro Optics Design and Simulation

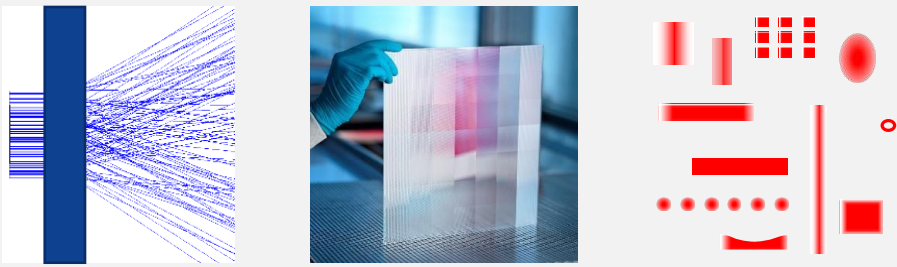

Acyindrical free-form micro-optics / arrays / diffusers / DOE splitters / beam shaping systems

Homogenization

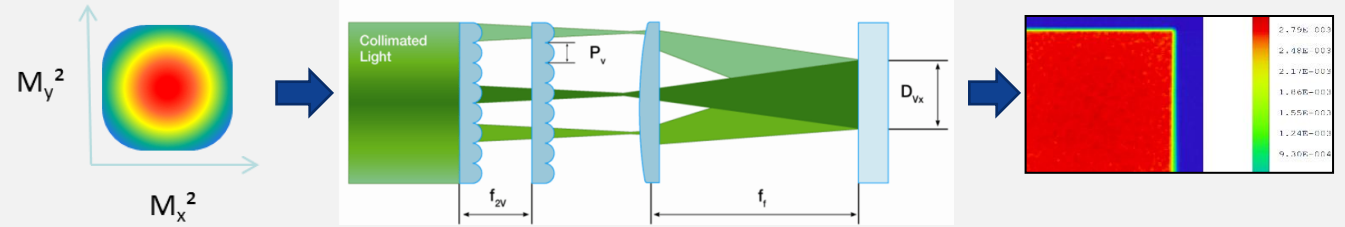

Uniform and homogeneous illumination in any desired shape

Beam Transformation

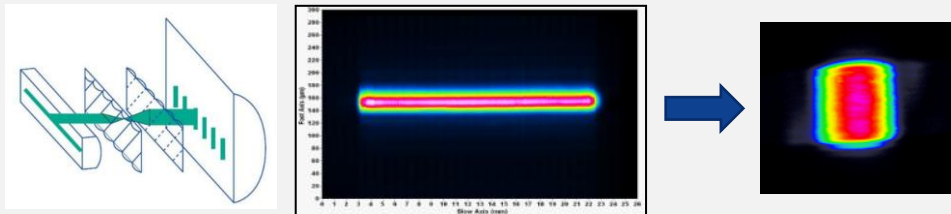

Asymmetrical → Symmetrical beam

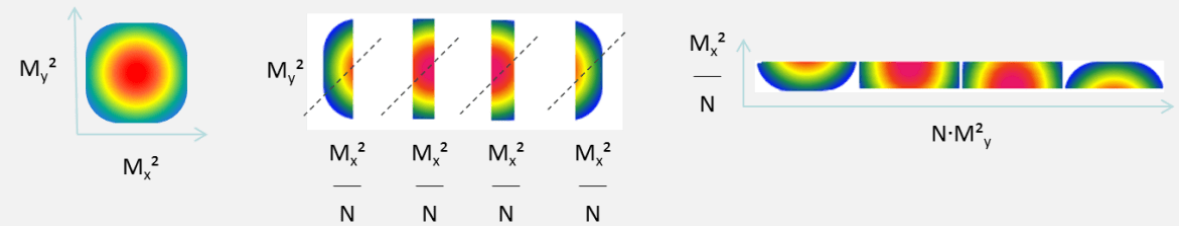

Symmetrical beam → High density line beam

Our UV-L750 System for Laser Lift-Off (LLO) was Prism Awards winner in 2018



Core Competence

Optics Manufacturing

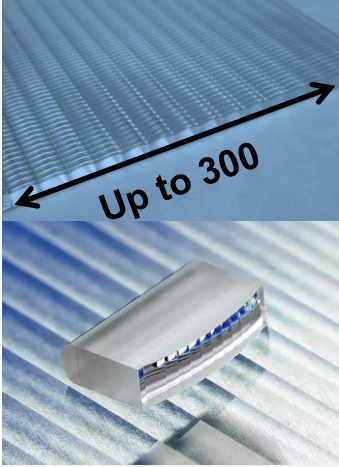
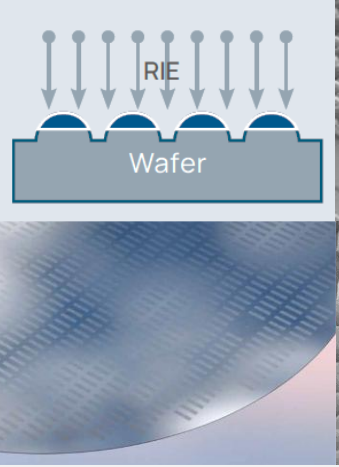
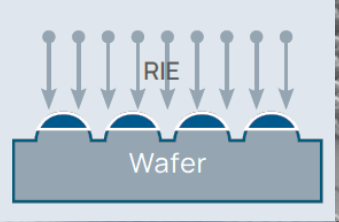
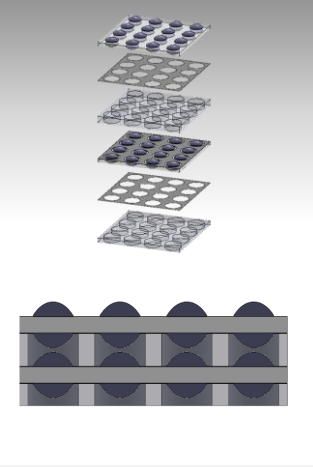
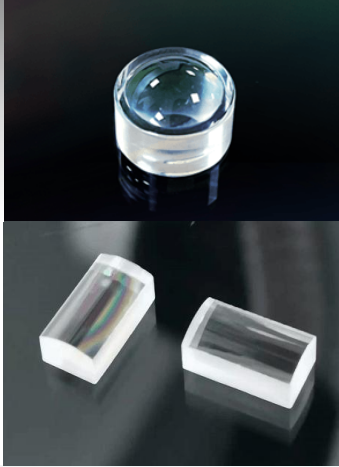
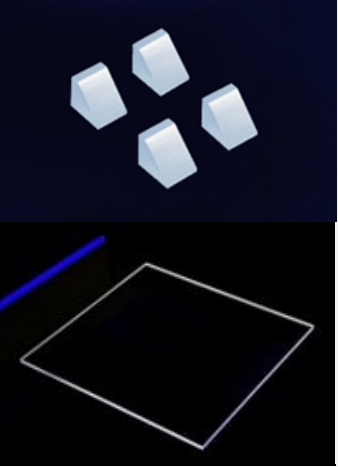
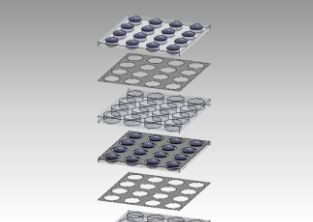
Wafer Level Simultaneous Structuring	Wafer Level Photolithography-RIE (reactive ion etching)	Wafer-Level Optics (WLO) Precision Imprinting	Wafer-Level Stacking (WLS)	Precision Glass Molding	Cold Processing	Roll to Roll
 <p>Up to 300</p>						
<p>With inorganic materials: Glass, Fused Silica, Silicon, CaF₂</p>		<p>With polymer on glass</p>		<p>With moldable Glass</p>	<p>With inorganic materials</p>	<p>From PET to PC to PMMA</p>
<p>High LIDT Optical Coating: Anti-reflection, high-reflection, beam splitter, band filter, and various customization (UV, VIS, IR)</p>						

Core Competence

Test, Analysis and Diagnosis

Test and Characterization of High-Power Diode Laser

A comprehensive physical diagnostic model allows full characterization of a set of key parameters, such as:

- LIV
- Spectrum
- Polarization
- Far-field / Near-field
- Spatial spectrum
- Spatial polarization
- Spatial beam profile
- Smile effect
- Lifetime

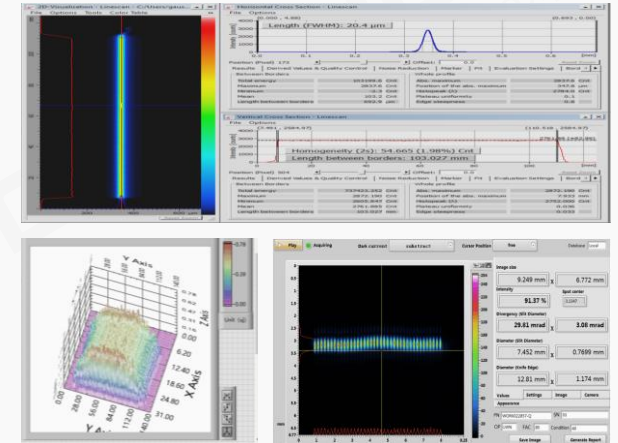

Metrology and Analysis of Optical Components

Wave optics models are used in conjunction with tactile surface measurements for precise analysis of optical functions such as:

- Focusing
- Collimation quality
- Beam uniformity

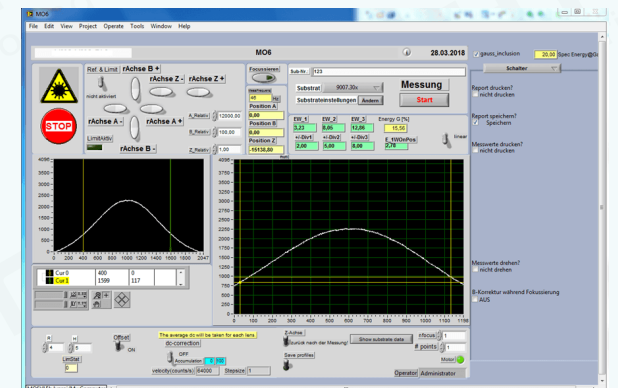

A Unified Quality Management System

Governance Framework That Drives Enterprise-Wide Quality Excellence

ISO9001 Certified Quality Management System (QMS)

ISO14001 Certified Environmental Management System (EMS)

IATF16949 Certified Automotive Quality Management System

ISO45001 Certified Occupational Health and Safety Management System

Failure Mode and Effect Analysis (FMEA)

Statistical Process Control (SPC)

Production Traceability Database

Control Plan (CP)



Quality Assurance System

Ensuring Product Reliability Through Rigorous Controls and Verification

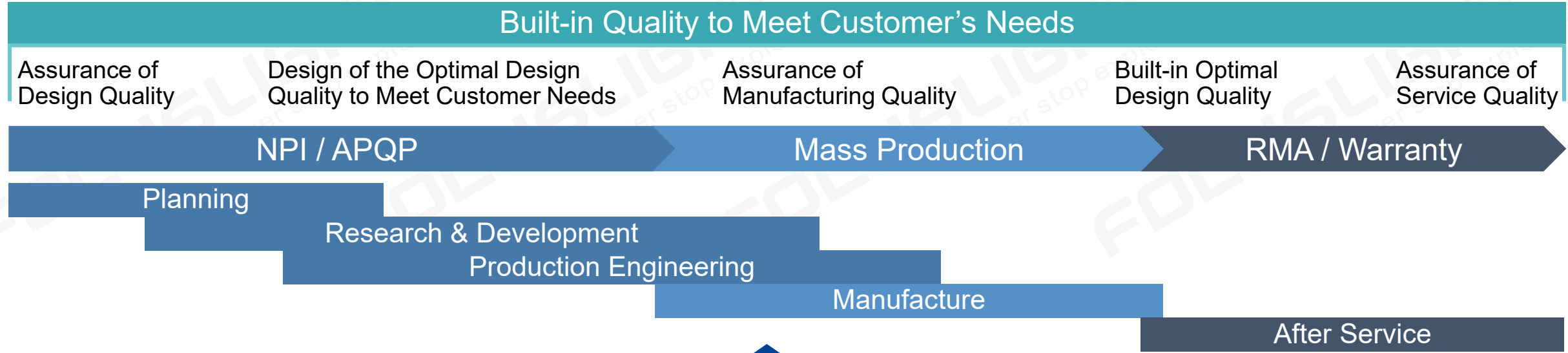

Promotion of Consistent Quality Assurance Activities

Quality Control System of Design	Quality Control System of Manufacture		Quality Control Evaluation System
<ul style="list-style-type: none"> • QFD • Critical Characteristic, Special Characteristics • Tolerance Chain Design • FMEA, FTA • Design Validation • Design Review 	<ul style="list-style-type: none"> • Parameter design • Process FMEA • Process Capability Study • Automatic Inspection, • Poka Yoke / Error Proof • Measurement System Analysis 	<ul style="list-style-type: none"> • QA Network • Supplier Quality Management • Production Validation • Control Plan • QC Circles • Production Part Approval Process 	<ul style="list-style-type: none"> • QC diagnosis • Quality assurance Meeting • Quality Auditing Improvement Meeting

Focuslight Manufacturing System (FLMS)

Building Stable, Efficient, and Scalable Production Capabilities

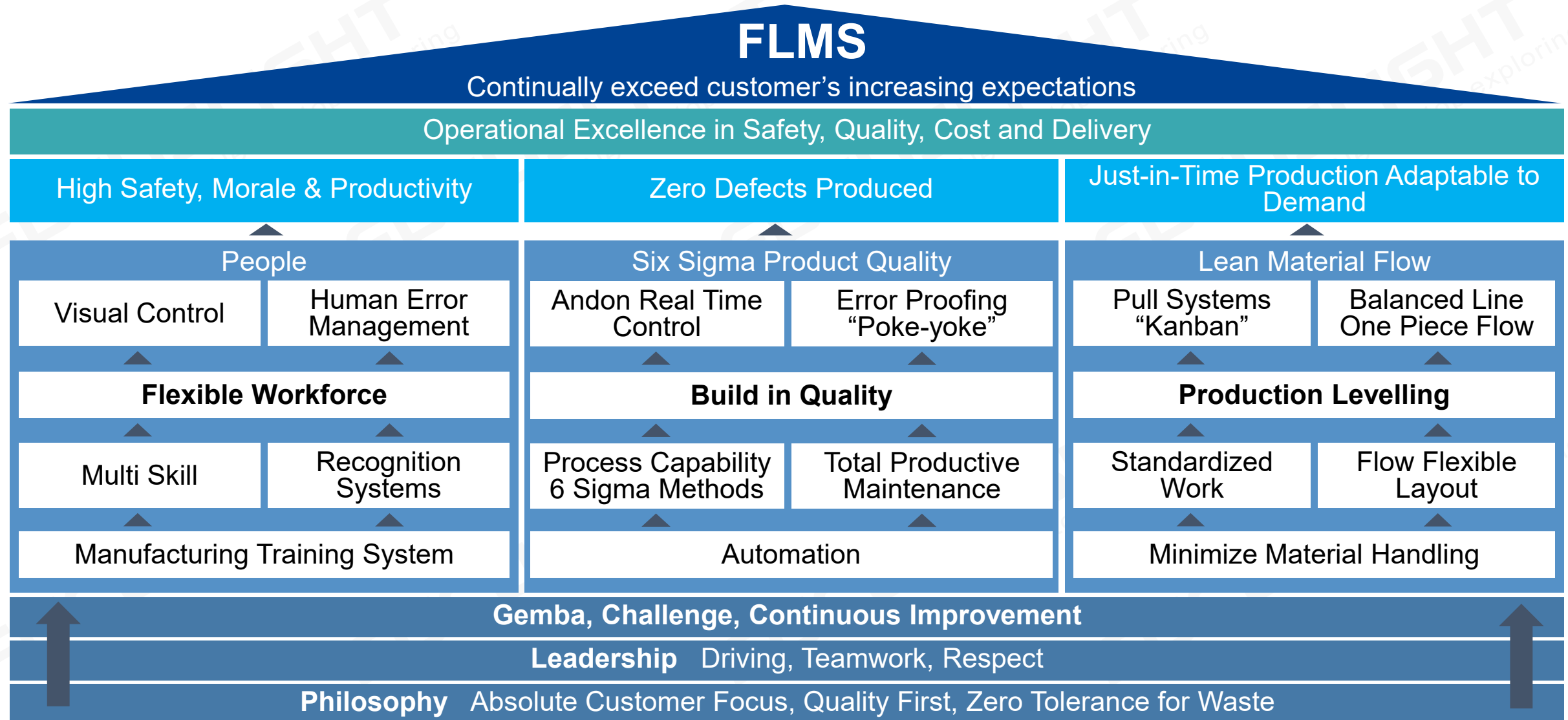

To Build the Focuslight Global Manufacturing System

Zero Accidents

Zero Defects

100% Value Added

100% Delivery



Local Manufacturing Ops



QCD-focused

- Collaboration within sites
- Limited cross-site / cross-BU collaboration

Global Manufacturing Ops



VSM improvement-focused

- End-to-end value stream integration
- Building an efficient global manufacturing system

Digital Manufacturing Ops



Data-driven decisions

- Big data based cost modeling & decision support
- Global MES: automated data collection & analysis
- Predictive metrics, early warning, fast response

Smart Manufacturing Ops



Self-optimizing manufacturing system

- Replicable lean capabilities
- System evolution & self-healing
- Lean system scaling with new business growth
- Autonomous decision-making, healing, and response

Strategy Execution

Fast Response

Empower Team

Automation, Digitalization, Intelligentization

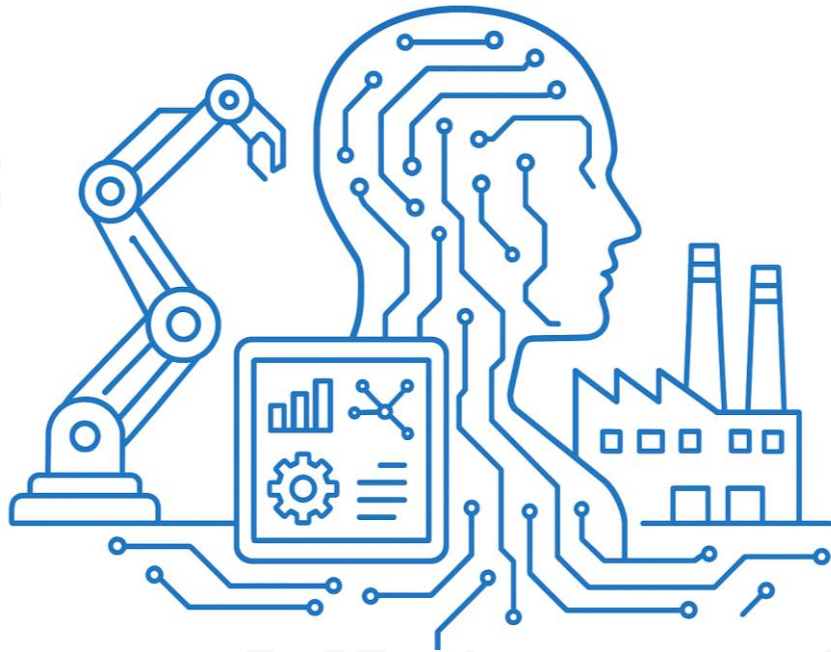

Equipment
interconnection

MES

- Improved efficiency
- Big data enhances quality through visibility

Big data boosts
decision

Testing

- AA (Active alignment)
- PA (Passive alignment)

Automation

- AOI
- P&P (pick & place)
- CD (collaborative development)

Automation Powered Operational Excellence

Automatic Optical Alignment



Automatic Assembly

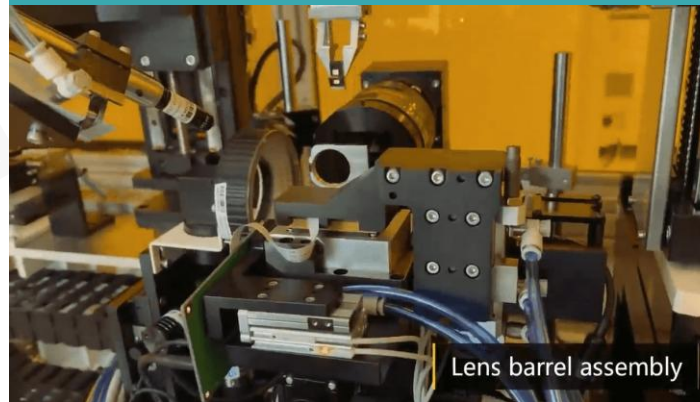

Automated Optical Inspection

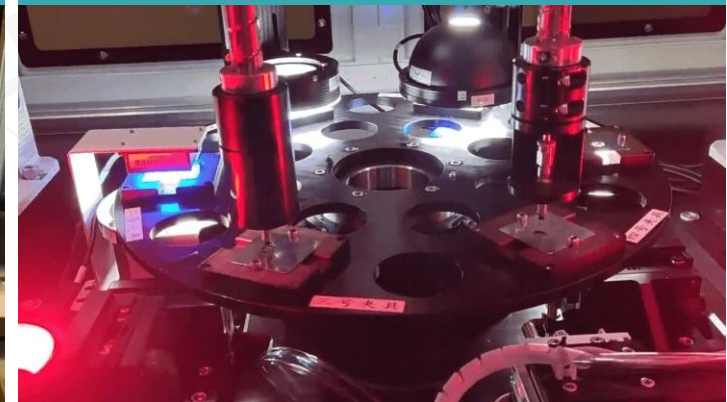

Laser Optics Production Line



LiDAR Transmitter Production Line



Big Data Powered Production

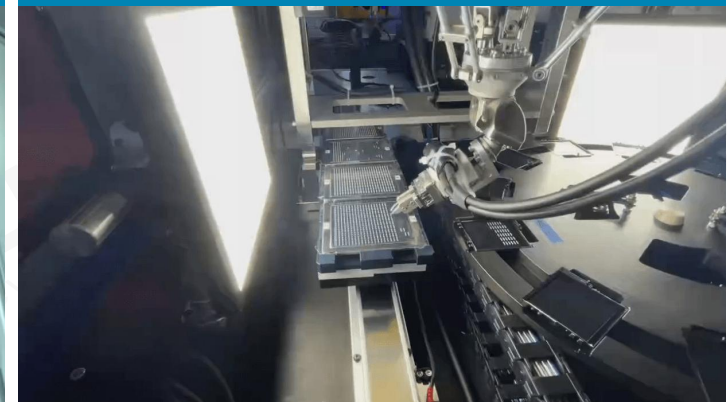

Video Link: <https://www.focuslight.com/news-events/newslst/focuslight-autonamation-powered-manufacturing-excellence/>

Manufacturing Capabilities

Advanced Materials

10+ years high-volume manufacturing experiences + self-owned core technologies

DPC production



Etching production



Au plating



Pattern production



Cleaning

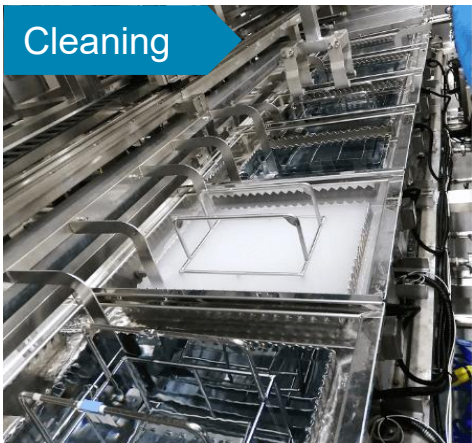

AuSn deposition



Laser marking



Dicing



AOI inspection



Advanced Materials Manufacturing Capacity > 2M pcs / month

Manufacturing Capabilities

Laser Sources

Packaging & Assembling



Optical Assembling



Testing & Measurement



Quality Inspection



Burn-in & Lifetime Test



Diode Laser Manufacturing Capacity > 500K pcs / year
Burn-in Capacity 600K pcs / year

Manufacturing Capabilities

Micro-Optics: Wafer-Level Simultaneous Structuring Processing

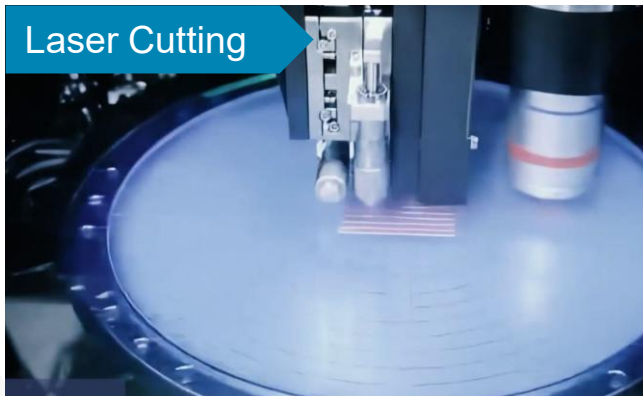
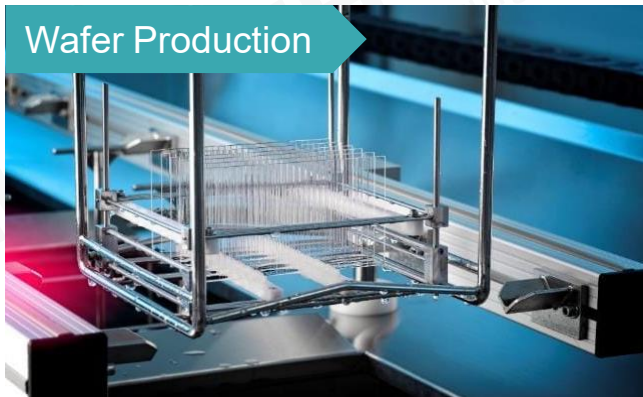

Wafer-Level Simultaneous Structuring Processing:
Manufacturing Capacity > 2K wafers / month or > 5M pcs lenses / month

Manufacturing Capabilities

Micro-Optics: Photolithography-Reactive-Ion-Etching Processing

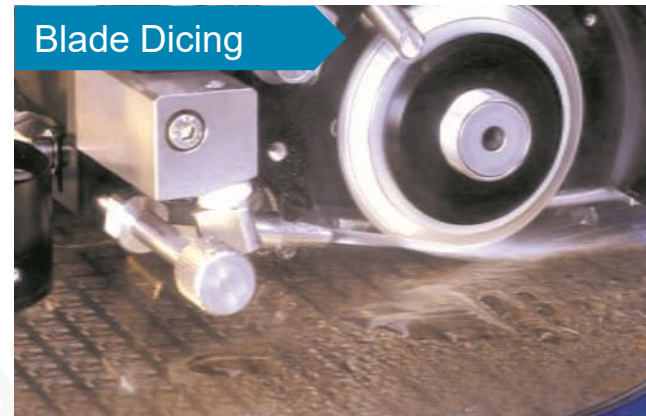
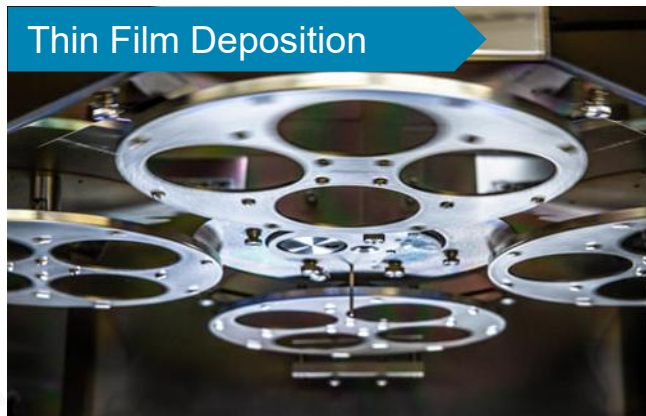
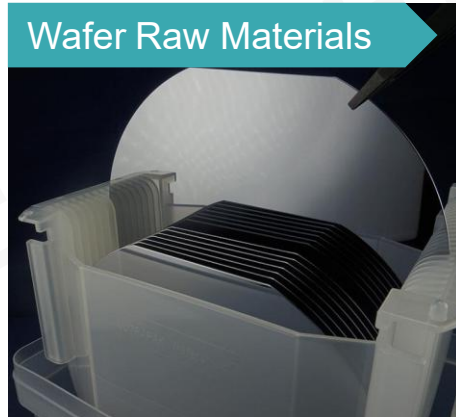

Photolithography-Reactive-Ion-Etching Processing:
Manufacturing Capacity > 300 wafers / month

Manufacturing Capabilities

Micro-Optics: Imprinting Processing

Mastering

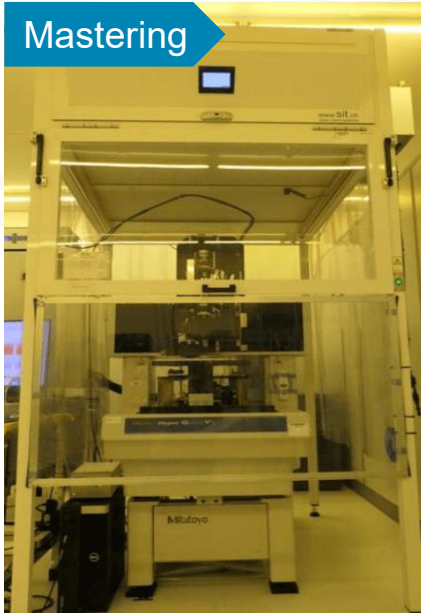

Replication



Stacking

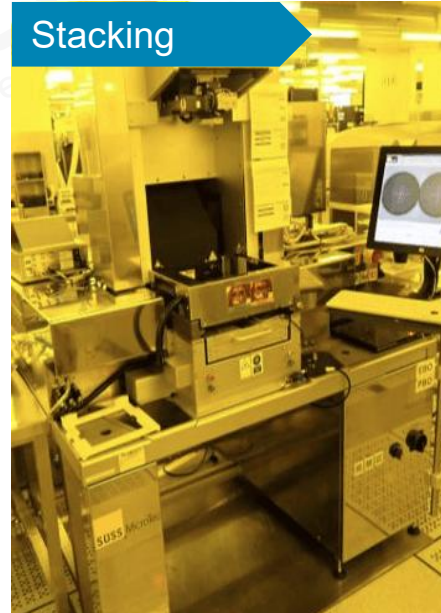

Testing



Singulation



Imprinting Processing:
Manufacturing Capacity > 2K wafers / month or > 8M pcs lenses / month

Manufacturing Capabilities

Micro-Optics: Precision Molding

Ultra-precision In-house Mold Making



Pressing / Molding



Coating

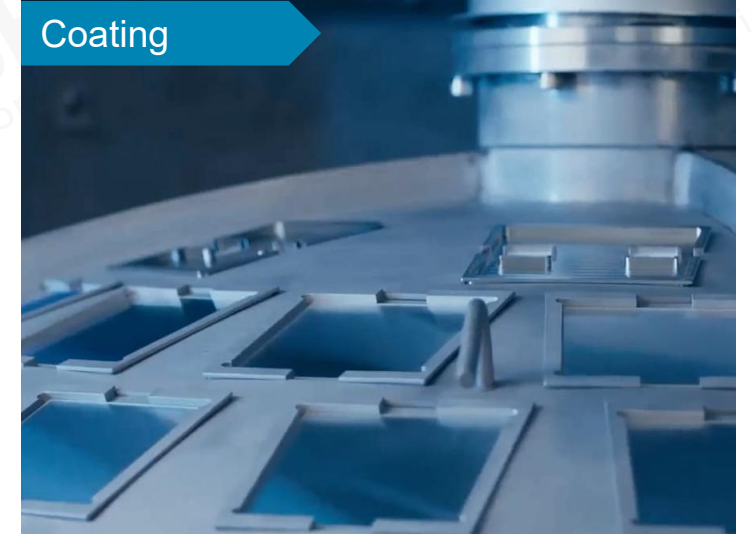

End Products



Barrel lens

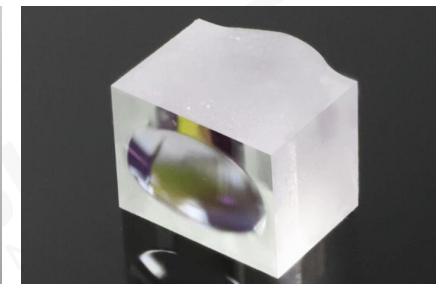

Bi-conic lens

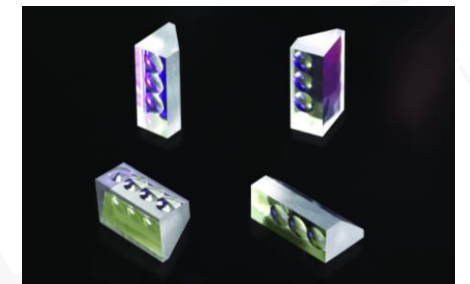

Microprism lens array

Precision Molding: Manufacturing Capacity > 2M pcs lenses / month

Manufacturing Capabilities

Micro-Optics: Roll to Roll

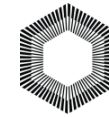

BRIGHTVIEW
TECHNOLOGIES



FOCUSLIGHT
Never stop exploring



AI Software Design

Multi-function, complex designs that can combine spatially variable shapes, structures, and densities in a single device creating a near infinite design space



Mastering

The software transfers the design to BrightView's custom **large format** grayscale photolithography digital tooling system

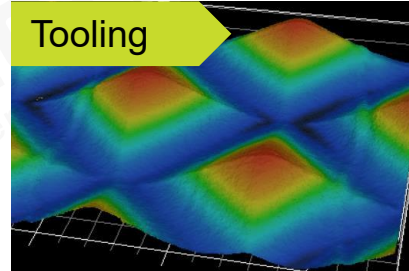

Tooling

Exceptionally consistent, low cost, high fidelity, large format consumable tooling is created from the master (or a 3rd party master)



Roll to Roll Replication

A high-volume, continuous, roll-to-roll clean room manufacture of products on a variety of substrates from PET to PC to PMMA in a range of thicknesses using in-house formulated resin options

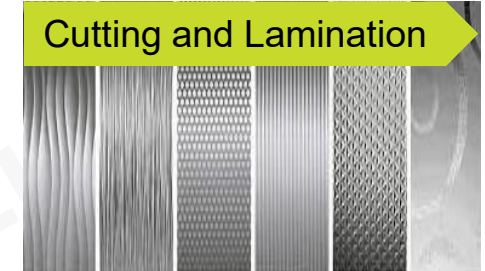

Cutting and Lamination

Large-format optical films are further cut and separated to smaller finished products or laminated on thick rigid board, following the needs of the final applications.

BrightView (US facility)

Focuslight (Asia facilities)

** More manufacturing processes can also be finished in Asia, if customer has confirmed needs of mass production.*

Typical Applications

Optical Communication

- High precision micro-optics are at the heart of optical communication systems.
- They support efficient data transfer between key optical components.

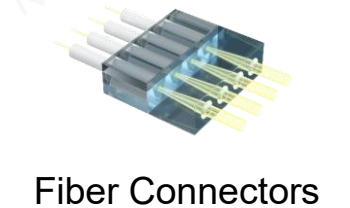
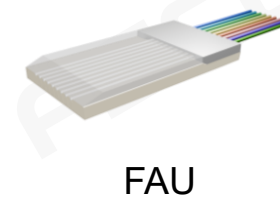
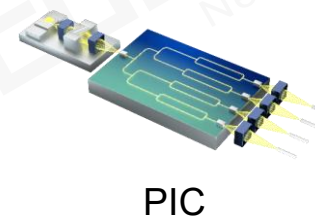
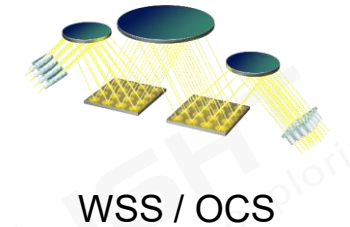
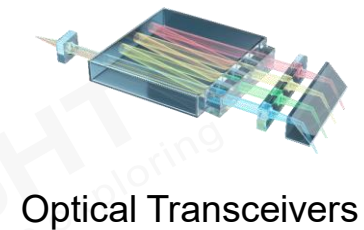
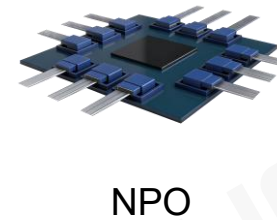
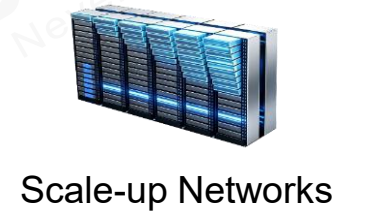
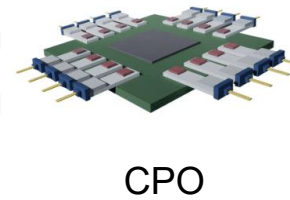
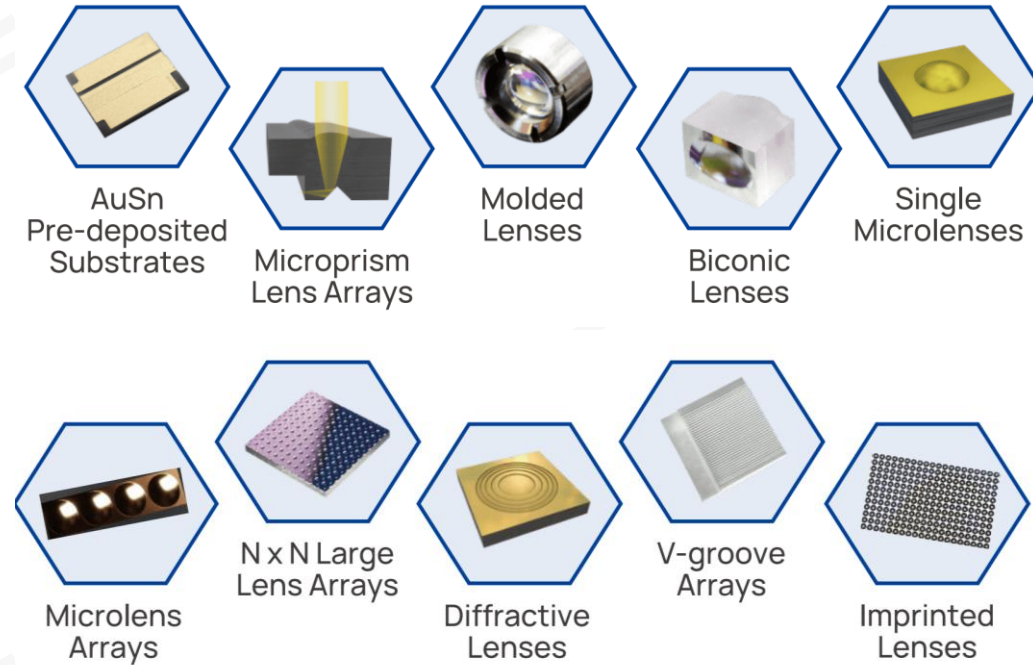

Typical Applications

Consumer Electronics

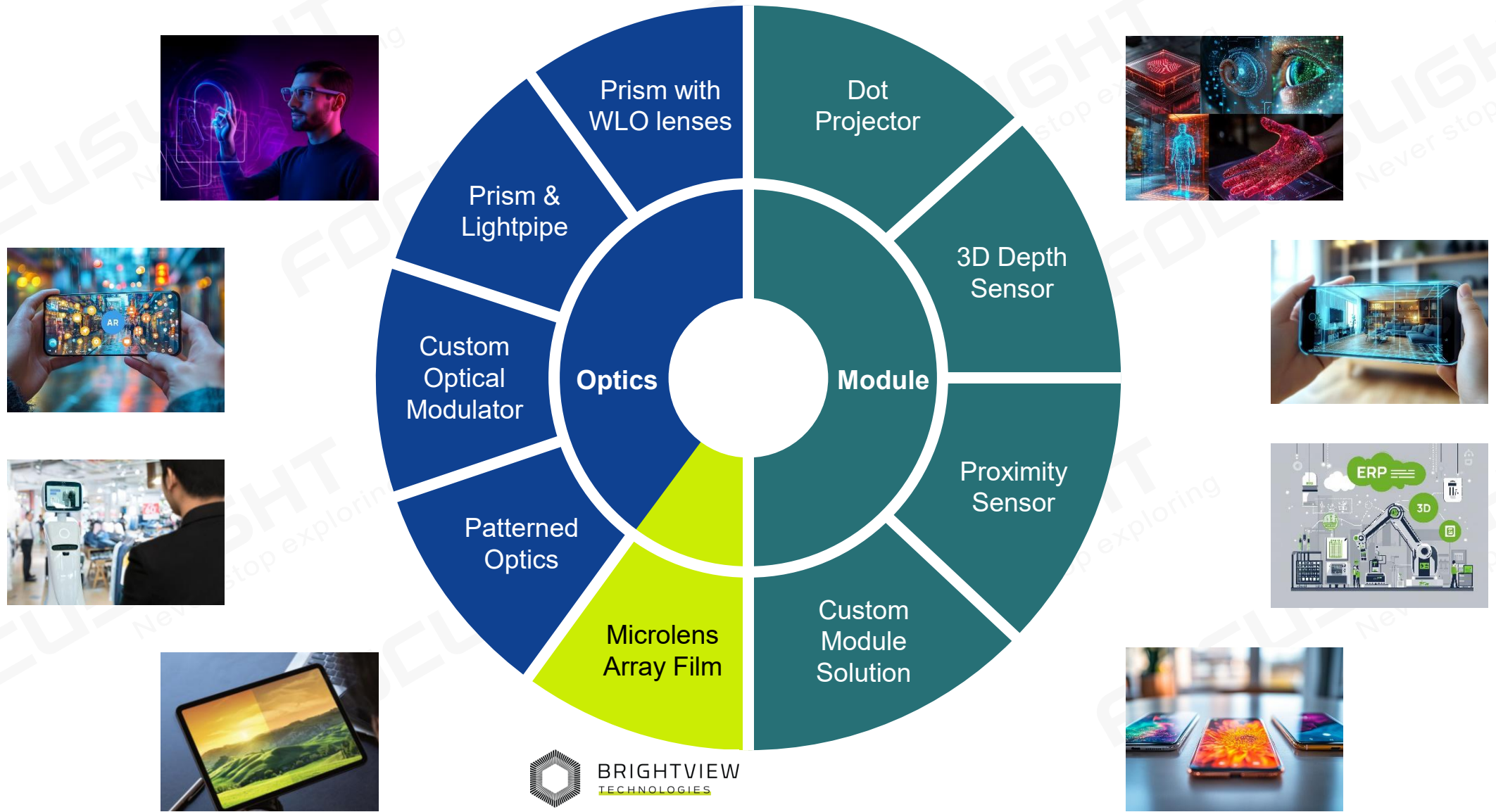

Typical Applications

Semiconductor

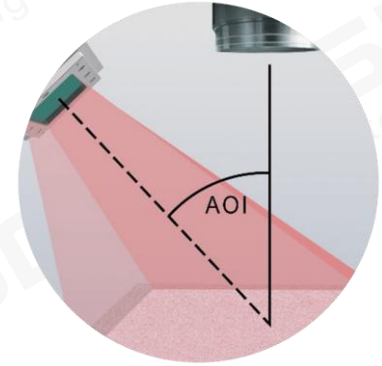
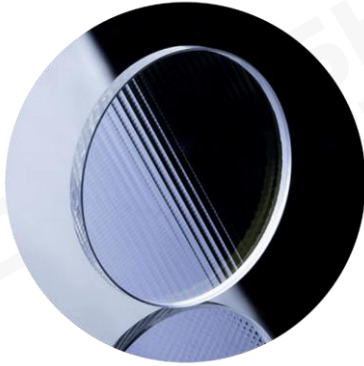

- Beam homogenization technology powers the illumination system – key optical component in **pan-semiconductor systems**
- > 15 years supply to the major manufacturer of semiconductor lithography tools

- Laser system solutions with high power density and different beam profiles, designed for various **laser-based wafer annealing processes** including IGBT backside annealing and SiC annealing

- Based on 976nm diode laser with adjustable beam output and >95% homogenization in energy distribution
- Ideal for **advanced chip packaging processes**, e.g. laser-assisted bonding

- Off-axis beam shaping technology powers laser surface treatment as well as surface inspection
- Typically used in **solar cell industry**

Typical Applications

Display Manufacturing



Solid-State Laser Lift-Off (LLO) for Flexible Displays

- Several tens of beam shapers (plasma display pixel structuring)
- Several green 100 mm line beam systems (laser lift-off)
- > 600 mm UV line beam production system (laser lift-off)

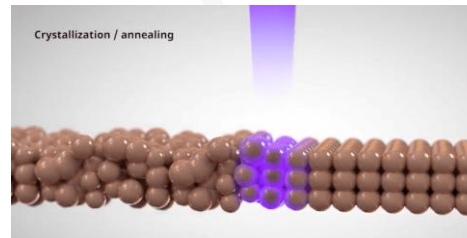

Next-gen LTPS Solid-state Laser Annealing Process

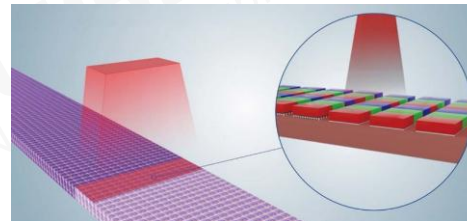

Mini and Micro LED Processing

- Laser Mass Transfer and Laser Mass Soldering
- Laser Chip Repair



Typical Applications

Automotive



LiDAR



Driver Monitoring System



Smart Headlight



Projected Lighting



AR HUD



Optical Components
and Assemblies



Laser Transmitter /
Illumination Modules



*Focuslight does not
produce LiDAR /
Lighting full system*

Typical Applications

Medical and Health



Hair Removal



Body Sculpting



Skin Rejuvenation



Ophthalmology



3D Interoral
Scanning



Dermatology

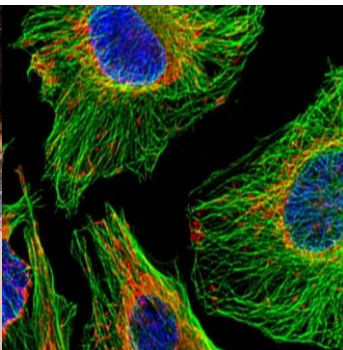

Confocal
Microscopy

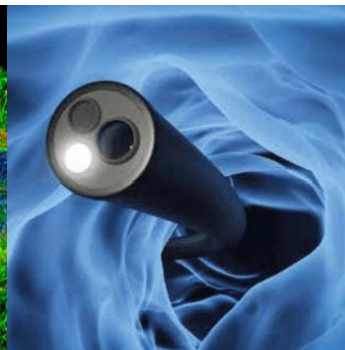

Endoscopy



Sensing



Laser Surgery



Optical Components;
Laser Components



Optical Solutions;
Laser+Optics Assembly;
Application Handpiece



Contract Manufacturing
Services



*Focuslight does not
produce medical or
health equipment*

Typical Applications

Industrial

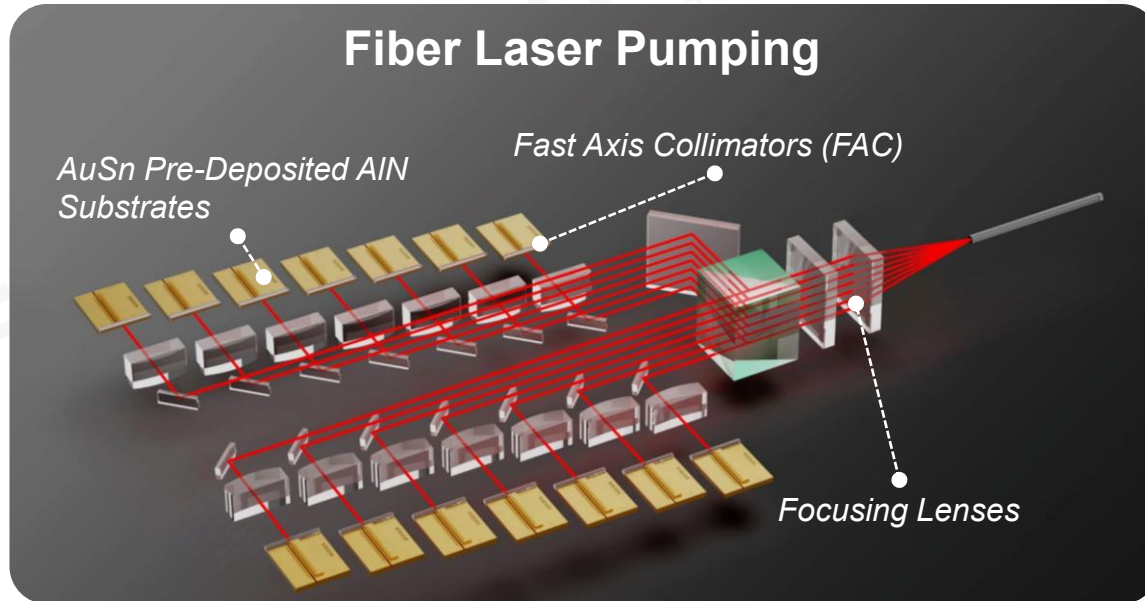

- **AuSn pre-deposited substrates** – stable and reliable thanks to the high thermal conductivity and suitable thermal expansion coefficient;
- **Fast axis collimators (FAC)** – fundamental and efficient solutions for shaping the beam emitted by the pumping sources;
- **Focusing lenses** – coupling the collimated laser beam precisely into the output fiber;

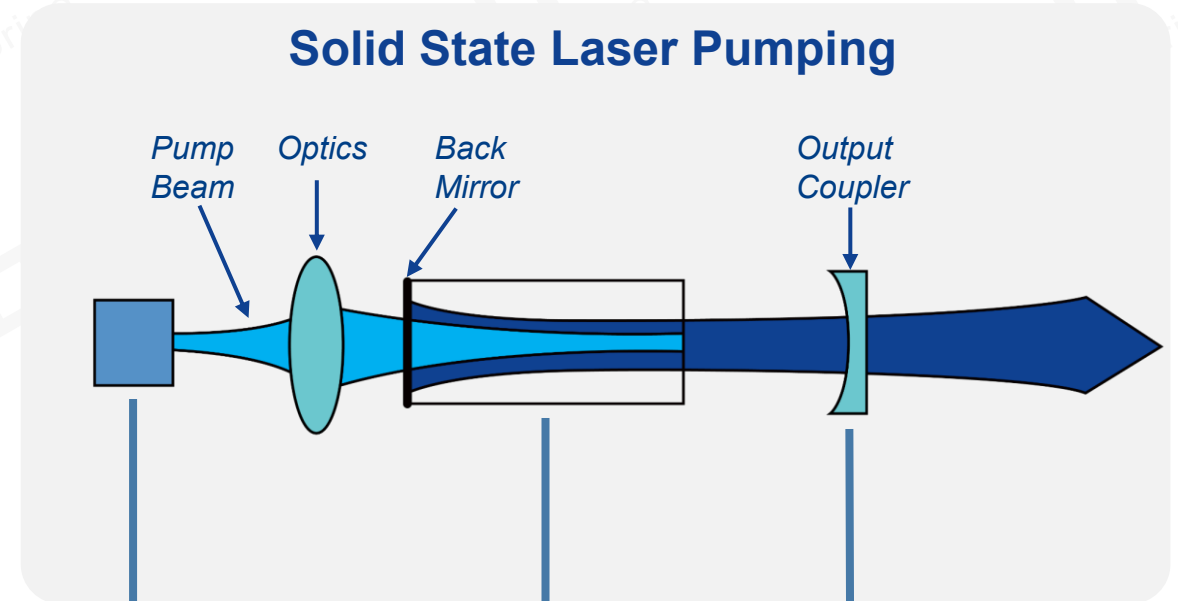

Diode Laser as Pumping Source

+

Gain Medium

+

Optical System

Footprint ↓

Reliability ↑

Efficiency ↑

Cost ↓

Typical Applications



BRIGHTVIEW
TECHNOLOGIES



FOCUSLIGHT
Never stop exploring

Advanced Display

Advanced displays must support **power hungry AI/video processors** while providing **high brightness, superb color rendering, and excellent image rendering.**

Challenges and Demands

- Use a passive mechanism to increase brightness
- Cost effective for consumers
- Increase display performance (color, uniformity, resolution)
- Thin, flexible, lightweight for portability
- Withstand range of environmental conditions
- Improve sustainability with thin, multi-function films

BrightView Computational Optics solutions

- **Display Enhancement Films:** Demonstrated up to 40% increase in brightness translating to 60-120 minutes of additional battery life
- **Zonal Films:** Gradient of micro lenses to correct color non-uniformity while maintaining brightness and HDR



Typical Applications

Lighting

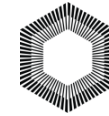

BRIGHTVIEW
TECHNOLOGIES



FOCUSLIGHT
Never stop exploring



Indoor Commercial



Indoor Architectural



Outdoor Architectural



Parking Garage



Stage Lighting



Horticulture

BrightView engineered **diffusers** and **microlens arrays** enhance lighting performance by improving light control, efficiency, uniformity, and visual comfort.

Sales Network

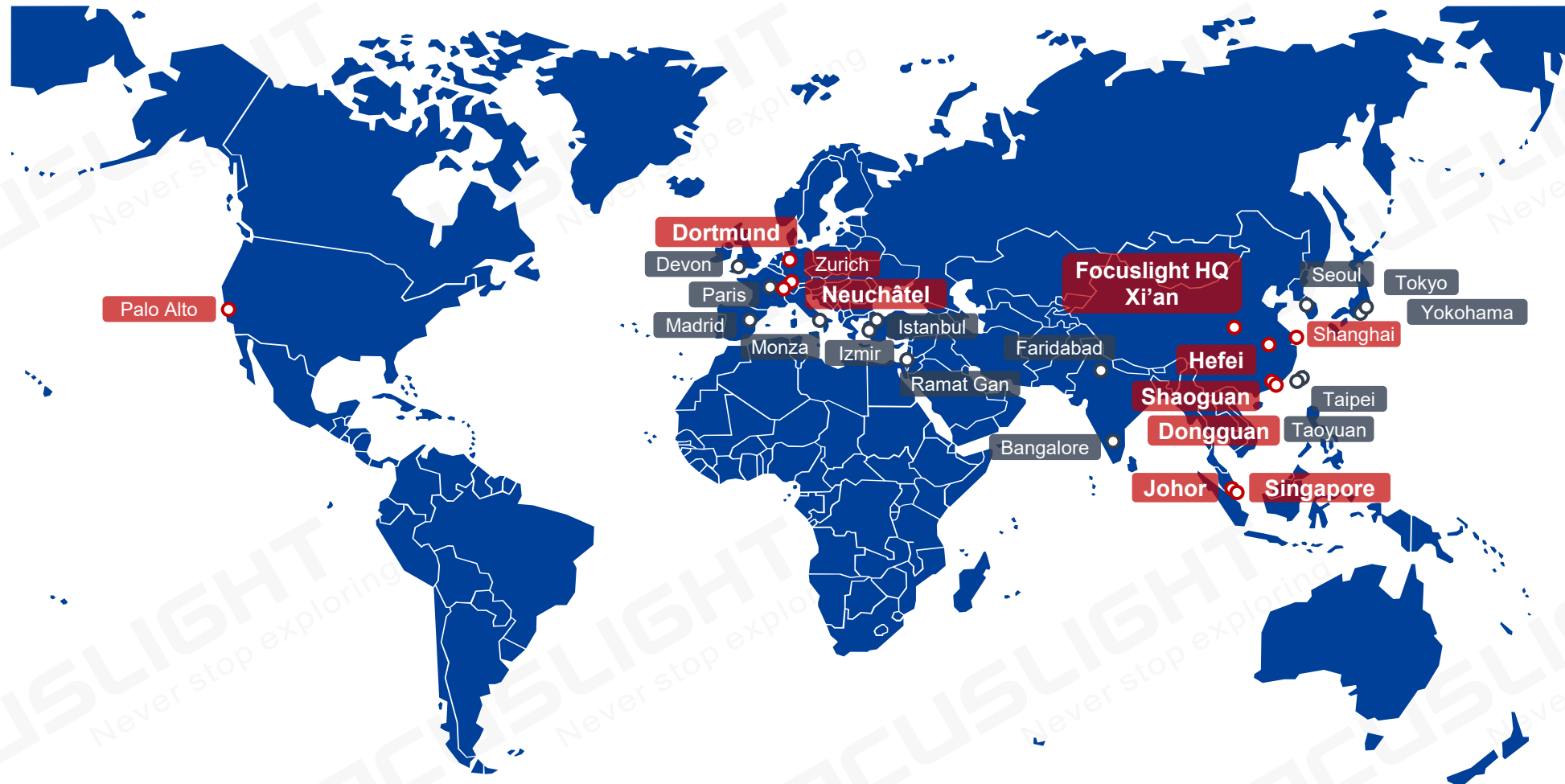

- Worldwide established distributors
- Direct sales offices in China, Switzerland and US
- R&D and operation centers in China, Germany, Switzerland, Singapore; Malaysia operation center being constructed

Your committed and reliable long-term partner in photonics components and solutions



Diode laser light source leader and beam shaping expert with strong IP position



One-stop-shop provider of micro-optics choosing from five process technologies best matching customer needs



Global photonics foundry that convert customers' ideas and designs into their own products and solutions



Total solution, versatile customization service and field service provider



Strong RDE capability, high volume production capacity and low-cost manufacturing



Financially healthy and strong financial backing from investors for long term growth

THANK YOU



www.focuslight.com

www.hptg.com

