

# Focuslight Corporate Overview

© Focuslight Technologies Inc.

2026-03

# Focuslight Overview

- Founded in 2007 by Dr. Victor X. Liu, headquartered in Xi'an, China.
- A fast-growing company that develops and manufactures:
  - **Laser sources and materials** (Photon Generation)
  - **Micro-optics** (Photon Control)
  - **Photonics module and system solutions** (Application Solutions) focusing on **optical communication, consumer electronics, and pan-semiconductor applications.**
- A **global photonics foundry** offering process development and manufacturing services to the global photonics community.
- Publicly listed in the Shanghai Stock Exchange (Ticker Symbol: 688167).



# Milestones



**2007**

Founding of Focuslight



**2018**

Dongguan delivery and high-volume manufacturing center officially in operation



**LIMO**

Lissotschenko Mikrooptik

**2017**

Acquisition of LIMO;  
Started providing photon control and photonics application solutions

**IPO**

**2021**

Successful IPO at Shanghai Stock Market

**FOCUSLIGHT**  
Never stop exploring

**2019**

Global branding identity upgrade



**HEPTAGON**

**2024**

Acquisition of ams OSRAM's optical component assets;  
Relaunch of Heptagon brand

**SUSS** MicroOptics

**2024**

Acquisition of SUSS MicroOptics



**2024**

Shaoguan Base officially in operation



**2025**

Hefei Base officially in operation

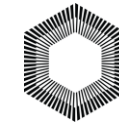

**BRIGHTVIEW**  
TECHNOLOGIES

**2026**

Announced strategic partnership with BrightView

# Focuslight Corporate and Subsidiaries

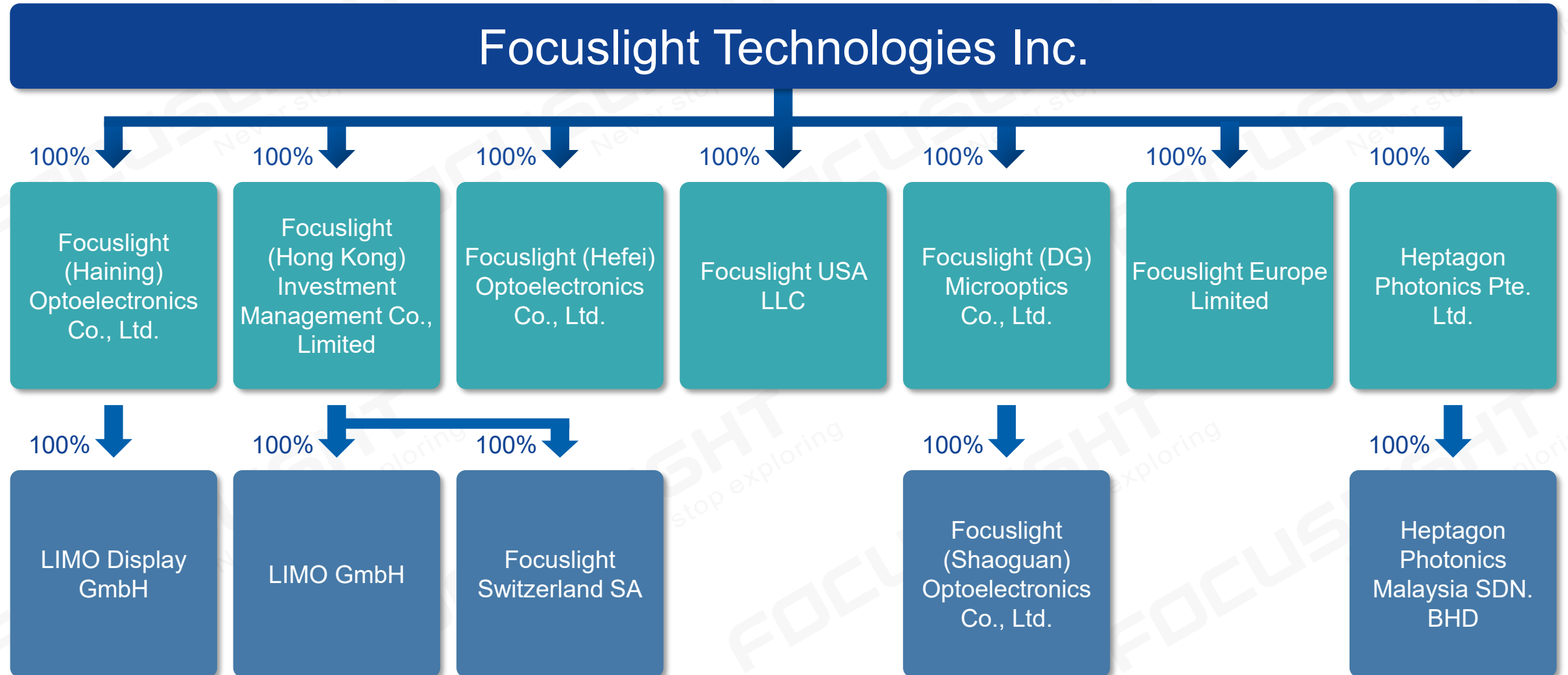

# Focuslight Global Operations System



**Zurich, Switzerland**  
R&D Office



**Neuchâtel, Switzerland**  
Operations Center



**Dortmund, Germany**  
Operations Center



**Xi'an, China**  
Focuslight HQ, Operations Center



**Hefei, China**  
Operations Center



**Shaoguan, China**  
Operations Center



**Dongguan, China**  
Operations Center



**Iskandar Puteri, Malaysia**  
Operations Center  
(being constructed)



**Ang Mo Kio, Singapore**  
Operations Center  
Business Center

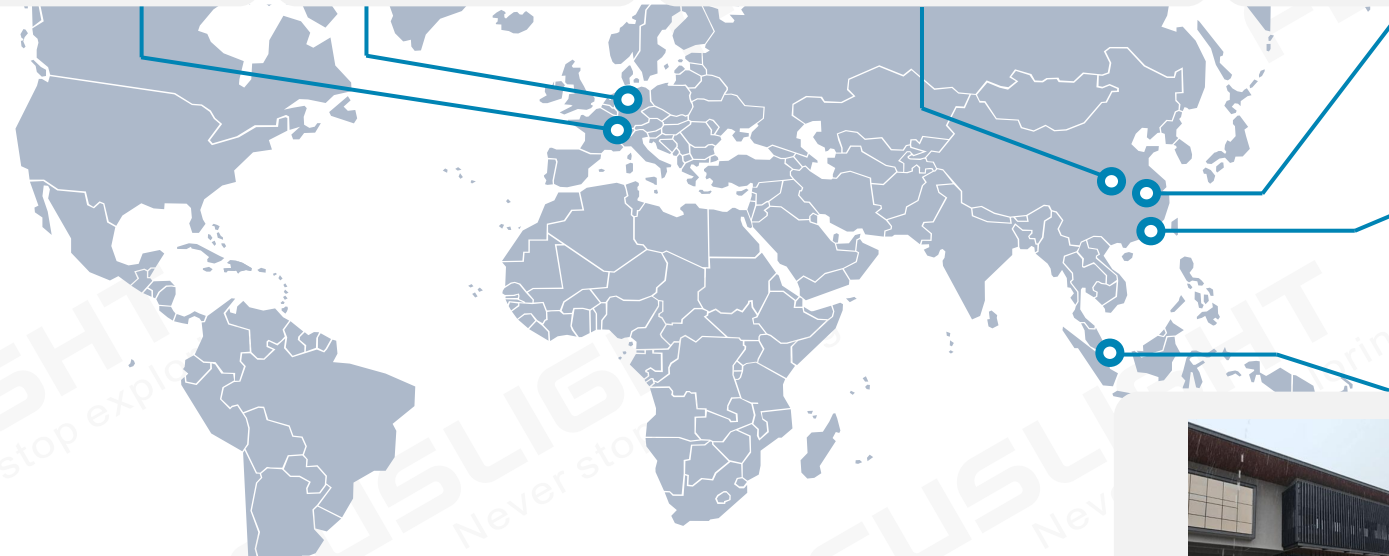

In a world of evolving market dynamics, we provide the solutions that support you to stay ahead –

**Optimized, efficient, cost-efficient, flexible, and forward-thinking.**

# Key Facts & Figures



Employees

>900



Revenue Proportion Invested  
into R&D (2025, unaudited)

~20%



Yearly Revenue  
(2025, unaudited)

**880M** RMB



Patents Valid  
Worldwide

>560



Facility Worldwide

>49,000m<sup>2</sup>

Clean Room Worldwide

>17,000m<sup>2</sup>































ISO 9001  
ISO 14001  
ISO 45001  
IATF 16949  
Certified

# Corporate Management Team

 <p><b>Dr. Xingsheng Liu (Victor)</b> Chairman, CEO</p> <p>Research and management experience in the US, with 100+ publications, 300+ patents, 30+ invited papers internationally</p> <p>Committee Member of SPIE and IEEE</p> <p><b>CORNING</b> <b>COHERENT</b> <b>nLIGHT</b></p>	 <p><b>Dr. Chung-En Zah</b> CTO</p> <p>30+ years of research experience in the US, with 300+ publications, 50+ patents in optoelectronics and telecommunication</p> <p>IEEE Fellow, OSA Fellow, 2x R&amp;D 100 award winner</p> <p><b>THORLABS</b> <b>CORNING</b> <b>Bellcore</b> <small>© Bell Communications Research</small></p>	 <p><b>Mr. Sinclair Vass</b> Corporate SVP of International Sales &amp; Business Development</p> <p>35+ years experience in international photonics markets, having held technical, commercial and general management leadership roles at major multinational companies</p> <p><b>Velodyne</b> <b>JDSU</b> <b>Lucent Technologies</b> <small>Bell Labs Innovations</small> </p>
 <p><b>Mr. Tan Chee Huo (Michael)</b> Corporate SVP of Business Process and IT</p> <p>25+ years in IT leadership, specializes in digital business transformation, global project management, multicultural team leadership in fast-paced international industries, and strategic decision-making</p> <p><b>NOKIA</b> <b>ThermoFisher</b> <small>SCIENTIFIC</small> <b>Tupperware</b> <b>EVIDENT</b></p>	 <p><b>Mr. Guowei Zhu (Gavin)</b> Vice President of Global Operations</p> <p>20+ years in international automotive companies, rich experience in IATF QMS and plant operations management by World Class Manufacturing (WCM) &amp; Lean manufacturing</p> <p><b>MAGNETI MARELLI</b> <b>BorgWarner</b> <b>GST</b> <small>SEITON AUTOLEATHER</small></p>	 <p><b>Mr. Lucas Zhang</b> Vice President of Global Operations</p> <p>20 years of global supply chain management experience at multiple Fortune 500 companies, with strong expertise in supply chain planning and management within the consumer electronics industry</p> <p><b>HUAWEI</b> <b>LCFC</b> </p>
 <p><b>Mr. Ye Dai (Robert)</b> Corporate VP of Global Sales</p> <p>Excellent track record in worldwide sales, product line and business unit management leadership roles</p> <p>20+ patents granted</p> <p><b>IVO</b> <b>APPLIED MATERIALS</b></p>	 <p><b>Ms. Yiping Ye (Alison)</b> Board Director, CFO</p> <p>Over 20 years management experience and multi-field business practices</p> <p>In-depth understanding in LTC, IPD, intercultural cooperation and rich operational experience in market development, project operation and business management</p> <p><b>HUAWEI</b> <b>Hanergy</b> <small>汉能</small></p>	 <p><b>Mr. Qichuan Yu</b> Chief Product/Process Officer</p> <p>Over 25 years of experience in wafer-level optics, optical sensor and camera packaging, SAW/BAW filter R&amp;D, and NPD execution, with a strong focus on mastering, tooling, and wafer-level processes</p> <p><b>amun</b> <b>OSRAM</b> <b>HEPTAGON</b> <b>EPCOS</b></p>

# Corporate Management Team

	<p><b>Ms. Xuefeng Zhang (Jennifer)</b> Board Director, Board Secretary, Marketing Director</p> <p>Over 15 years photonics industry international business experience, in-depth understanding and rich experience in sales, marketing and business development</p>  		<p><b>Mr. Hong Wang</b> Corporate R&amp;D Director</p> <p>PhD in physics and Master in computer science. 20+ years in quantitative analytics, capital market risk modeling and architecting. Expert in building analytic infrastructure and system. Rich experience in multinational team management.</p>   
	<p><b>Mr. Dirk Walter Bogs</b> President of Laser Optics BU</p> <p>Over 25 years' experience in ultra-precision tooling, optic manufacturing, engineering &amp; project management, and operational management Very deep knowledge of technology development and optimization</p> 		<p><b>Mr. Yong Tian (York)</b> VP of Laser Optics BU</p> <p>20+ years of operation &amp; R&amp;D management, very deep knowledge with organic optical materials and optical coating technology, published SCI articles and owns patented technologies. Experienced in Lean Manufacturing &amp; Industry 4.0</p>  
	<p><b>Mr. Weiyi Gu</b> President of Laser Source and Applications BU</p> <p>13 years experience in photonics R&amp;D and product management, with rich track records of leaderships in developing and delivering system solutions for pan-semiconductor and industrial applications</p> 		<p><b>Mr. Vicknes Ratha Krishnan</b> VP of Laser Source and Applications BU</p> <p>Proven business leader, 16+ years in program and product management within optoelectronics and semiconductors, working with multinational companies and top-tier customers.</p>    
	<p><b>Mr. Hongyuan Liu (Tom)</b> President of Global Photonics Foundry BU</p> <p>20+ years in R&amp;D and operations management, specializing in optical imaging and non-imaging system design, WLO process &amp; integration, and optical component manufacturing. Proven track record in new product development and scaling high-volume production</p>    		<p><b>Dr. Tobias Senn</b> Head of Strategic Growth R&amp;D</p> <p>15+ years of experience in micro-optical component development for the consumer market. Expert in design for manufacturing and process development, with a strong focus on high-volume production and yield improvement</p>    

# Business and Branding

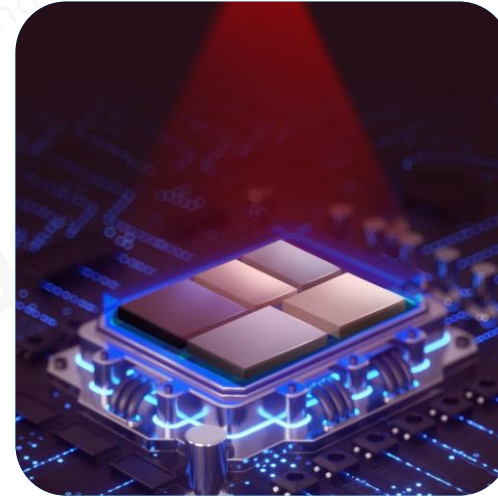
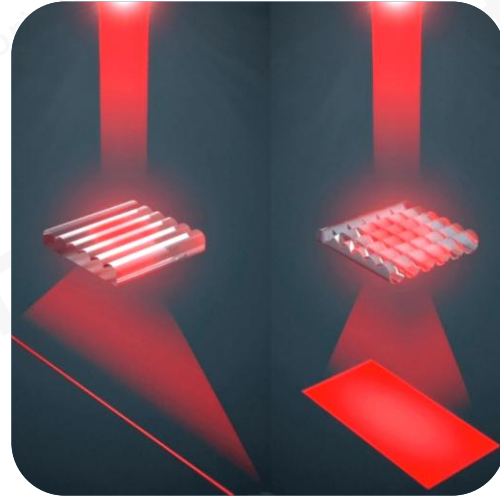
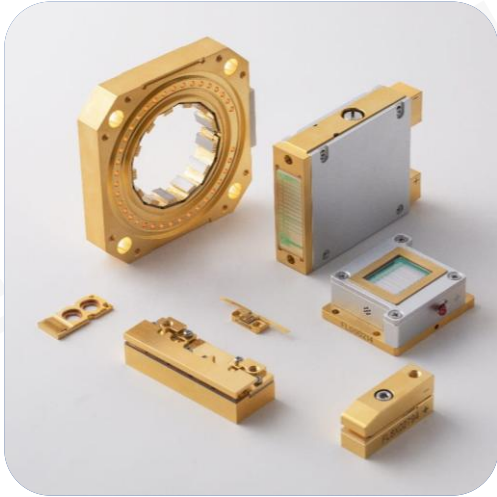

Photon  
Generation



Photon  
Control



Photonics  
Application  
Solutions



Global  
Photonics  
Foundry

**FOCUSLIGHT**  
Never stop exploring



 **HEPTAGON**

# Markets

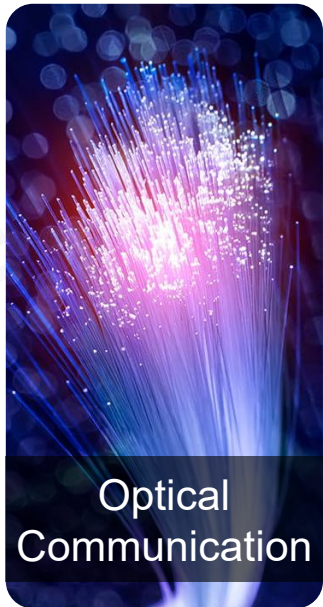

7%  
revenue

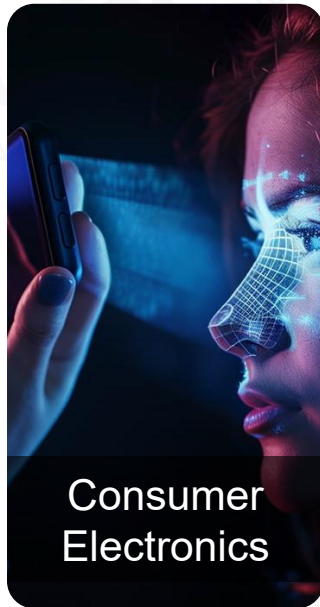

9%  
revenue

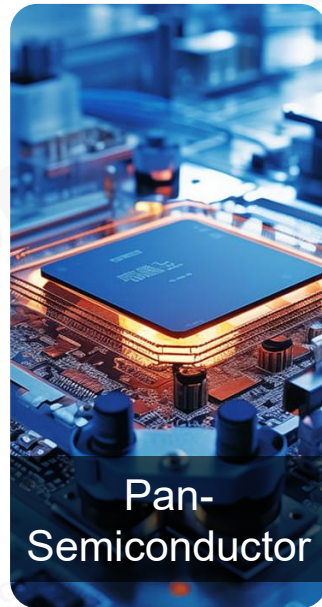

21%  
revenue



19%  
revenue



12%  
revenue



30%  
revenue

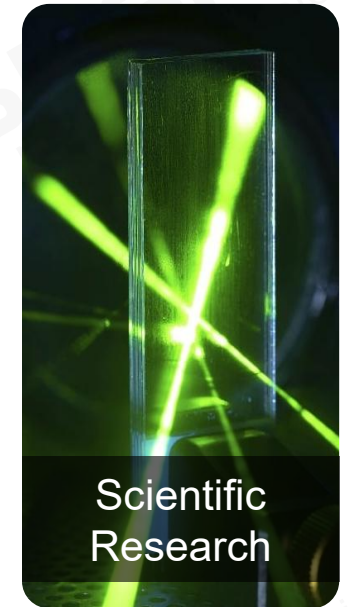



2%  
revenue



*\* Based on accumulated revenue data from 2025 Q1-Q3 (figures unaudited)*

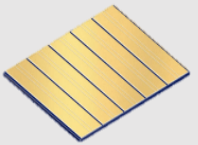

# Value Proposition



## Total Solution and Service in Full Value Chain

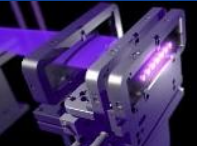

	<b>Chips</b> (Strategic collaboration with Suppliers)
	<b>Packaging Materials</b>
	<b>Optics Substrate</b>

	<b>Light Sources</b>
	<b>Optical Components</b>
	<b>Fiber Coupled Modules</b>

	<b>Laser Subsystems</b>
	<b>Optical Subsystems</b>
	<b>Integrated Modules</b>

	<b>Application Centers</b>
	<b>Technical Support</b>
	<b>Field Service Centers</b>

Industry Leader + Strong Financial Backing + Healthy Stable Company + Invest in the Future



## Do what we do best

Offer the best value

Optimize to the extreme

Achieve the best performance / quality-to-price ratio

## Commitment to Customers

- Lowest cost manufacturing for high volume products
- Willing to take technical risk, but request customer commit market share in return
- Willing to take investment risk in R&D and capital including M&A for customer but request customer commit market share in return
- Collaboration transparency, fast response, IP protection and long-term partnership



## What we don't do

Take high market risk

Be greedy

Be too aggressive

Compete against our customers

## Vision

To unlock the potential of photonics to enhance and enrich people's life



## Mission

*Be the global trusted photonics solution provider through innovation, operational excellence and fast response*

# Products and Services

## Micro-Optics

### Single Lenses and Linear Lens Arrays



FAC



SAC

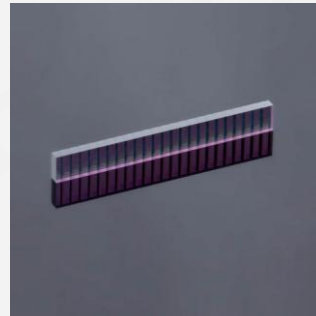

SAC array



BTS



Fiber coupler and collimator

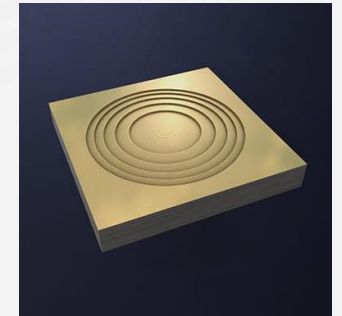
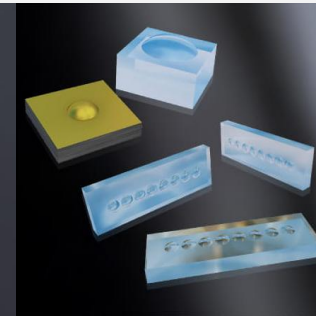

Collimating DOE

### Area Lens Arrays



Homogenizer and diffuser

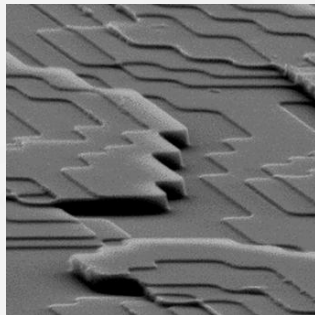

DOE beam splitter, dot or line generator



Shack-Hartmann array

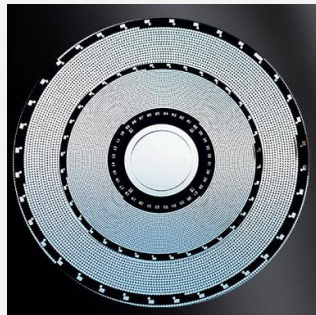

Pinhole array

### Plano Optics and Coatings

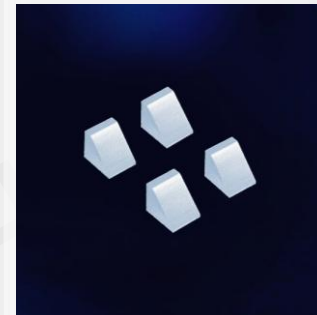

Micro prism

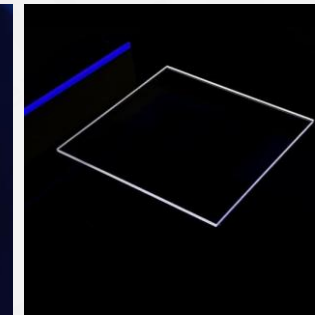

Window

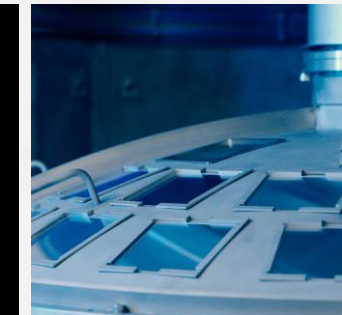

Optical Coating

# Products and Services

## Laser Sources and Materials

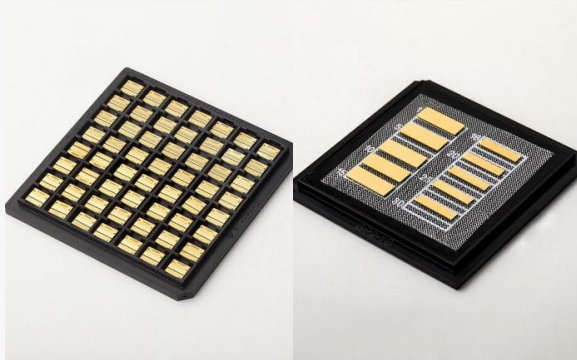

### Advanced Materials

- AuSn Pre-Deposited AlN Ceramic Submounts
- AuSn Pre-Deposited CuW Submounts



### Open-Package Diode Lasers

- Single Emitter Components
- Single Bar Components
- Micro-Channel Cooled Stacks
- Conduction Cooled Stacks
- Pumped Modules



### Fiber-Coupled Diode Lasers

- Emitter-Based Modules
- Bar-Based Modules

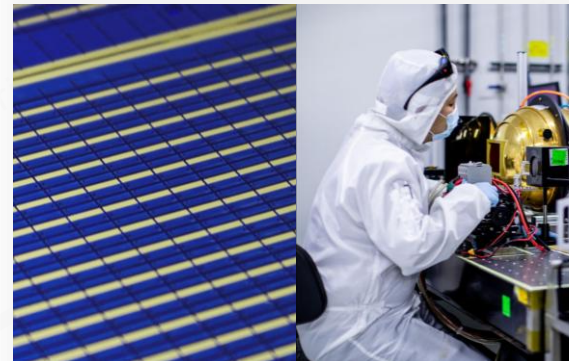

### Technical Services

- Thin Film Metallization Service
- Diode Laser Manufacturing Service

# Products and Services

Medical and Health Application Solutions

**Laser Hair Removal  
Modules**



**Laser Skin  
Rejuvenation  
Modules**



**Laser Body  
Sculpting Modules**



**Diode Laser Drivers**



# Products and Services

## Pan-Semiconductor Application Solutions

### Advanced Display Manufacturing



Solid-State Laser Lift-Off (LLO) System



Solid-State Laser Annealing (SLA) System



Variable Beam Laser System  
(Mini and Micro LED Processing)

### IC Manufacturing

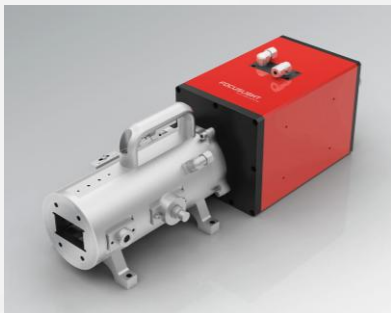

IC Wafer Annealing  
System



Variable Beam Laser System  
(Advanced Chip Packaging)

### Industrial Solutions



IR Line System

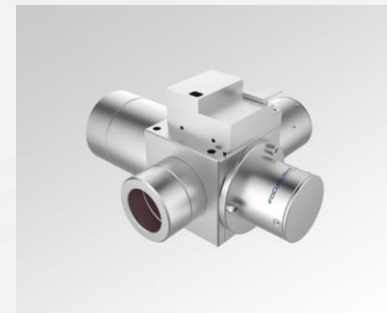

Industrial Laser Module

### Technical Service



End-to-end Technical  
Services

# Products and Services

Wafer Level Optics, Wafer Level Stacking, Wafer Level Integration

## Wafer-Level Optics



Micro lens arrays, diffusers, DOEs,  
Fresnel lenses

## Wafer-Level Lens Modules

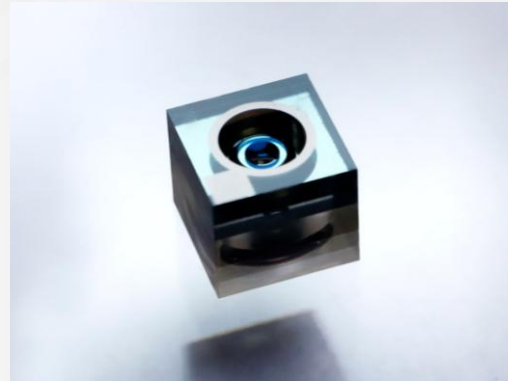

Stacked imaging lens modules  
compatible with CMOS

## Sensor Module Packaging Service



Packaging service for sensor  
modules

## Semiconductor Foundry Service



Imprinting of optical components or  
lens modules on silicon wafers (e.g.,  
for sensors, VCSELs, MicroLEDs)

# Products and Services

Consumer Electronics Solutions

## Beam Shaping and Pattern Generating



Pattern-Generating  
MLA



Engineered Diffusers

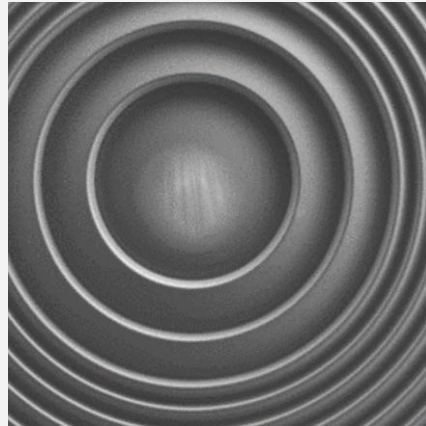

Diffractive Optical  
Element (DOE)

## Imaging and Projection

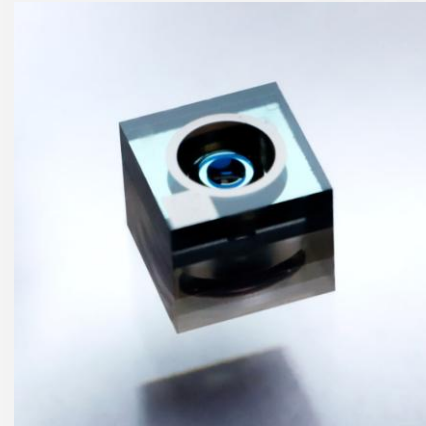

Imaging Lens Modules



Projection Lens  
Modules

# Products and Services

## Automotive Application Solutions

### Projected Lighting

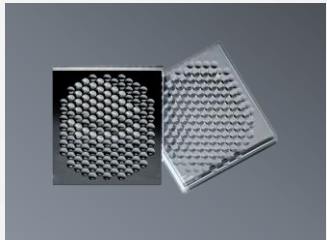

Microlens Arrays for Projection



MLA-Based Dot Projectors

### Smart Headlights

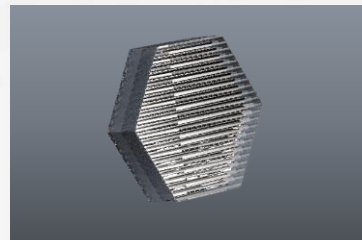

Microlens Arrays

### Driver Monitoring System

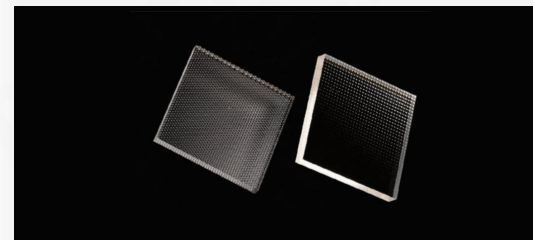

Homogenizers / Diffusers for Illuminators

### AR HUD

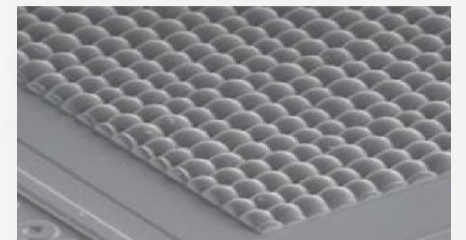

Homogenizers / Diffusers

## LiDAR

### EEL / VCSEL Based LiDAR Transmitter Modules



VCSEL Flash Transmitter  
700W



905nm 700W EEL  
Line Beam Transmitter



VCSEL Line Transmitter  
1000W

### Beam Shaping Optics

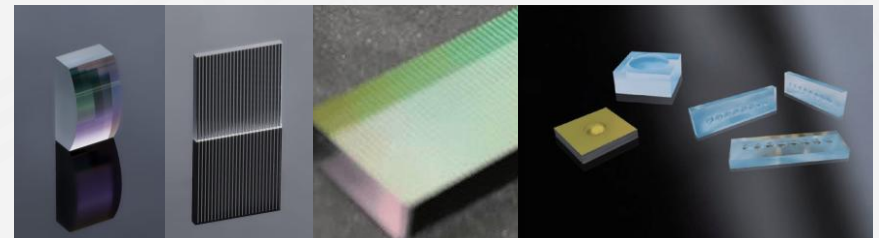

Fast Axis Collimators, Diffusers, Homogenizers,  
Collimators and Arrays in Glass, Polymer and Silicon

# Global Photonics Foundry Services

From Concept to Mass Production

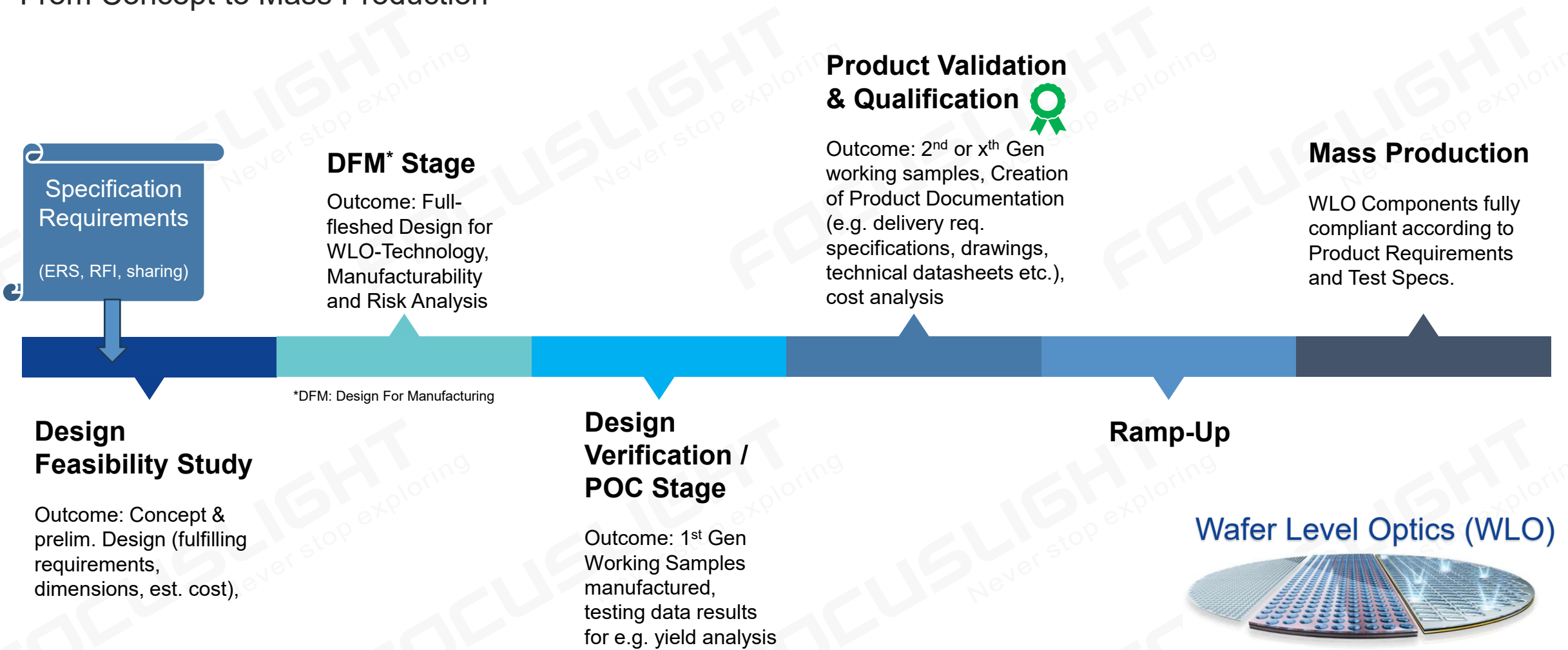

# Core Competence

## Diode Laser

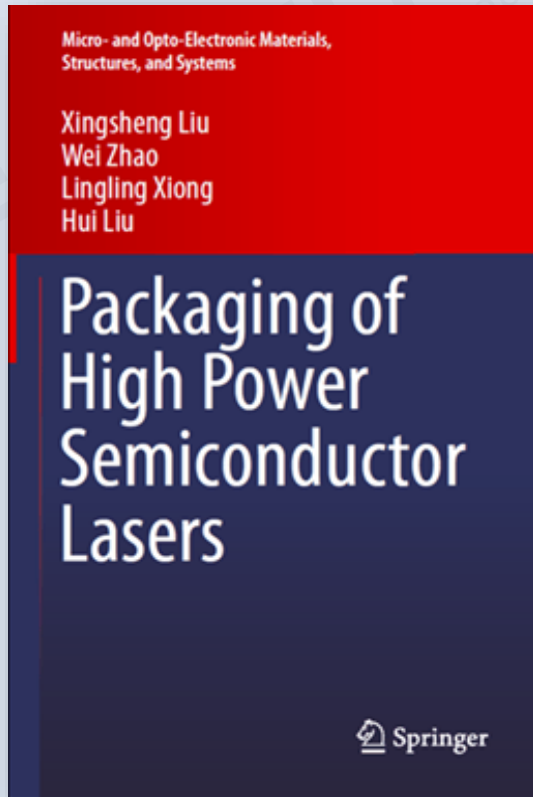

### Eutectic Bonding

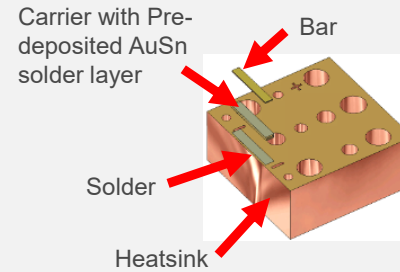

Significantly enhances thermal conductivity, reducing thermal stress, and thus improving the products' performance and lifetime

### Thermal Management

#### Finite Element Thermal Analysis and Design

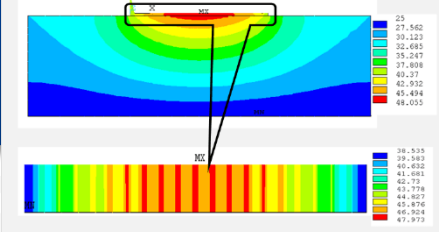

Effectively improves the ability of heat dissipation to ensure a higher output power

### Thermal Stress Control

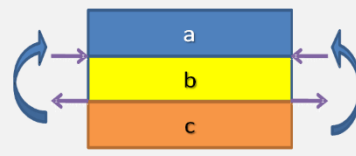
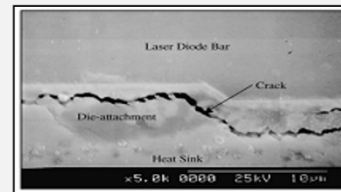

Lowers and homogenizes the thermal stress, and improve the device performance

### Interface Materials and Surface Engineering

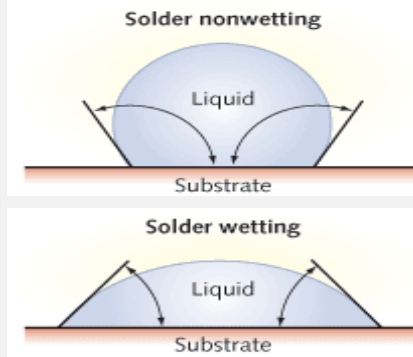

Greatly improves wettability and bonding strength of packaging materials, enhancing long-term reliability

# Core Competence

Beam Shaping – *The Right Photon at the Right Place and Time!*

## Micro Optics Design and Simulation

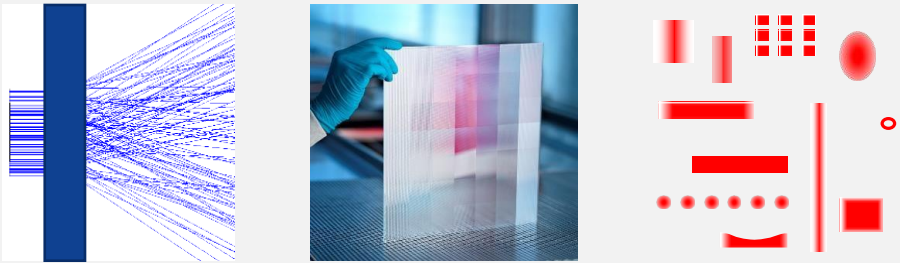

Acyindrical free-form micro-optics / arrays / diffusers / DOE splitters / beam shaping systems

## Homogenization

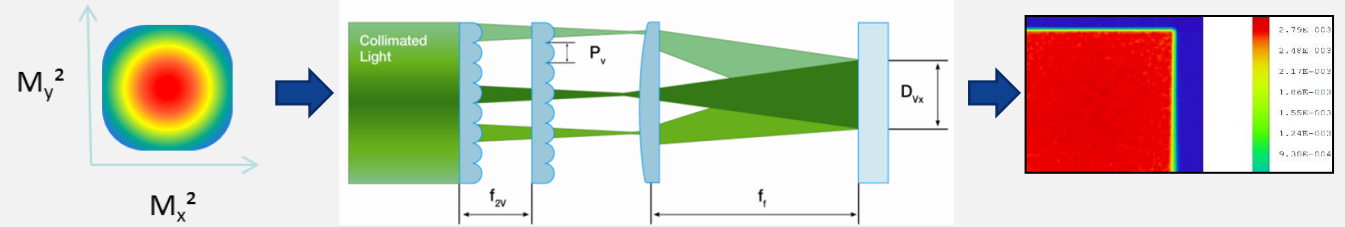

Uniform and homogeneous illumination in any desired shape

## Beam Transformation

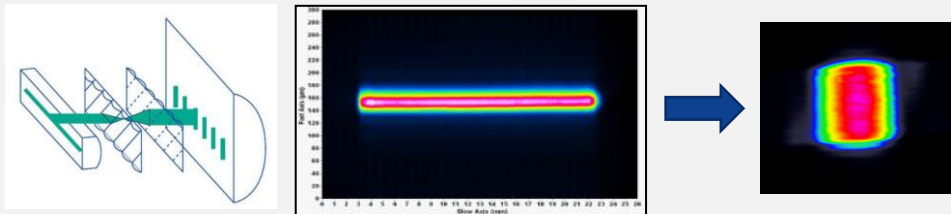

Asymmetrical → Symmetrical beam

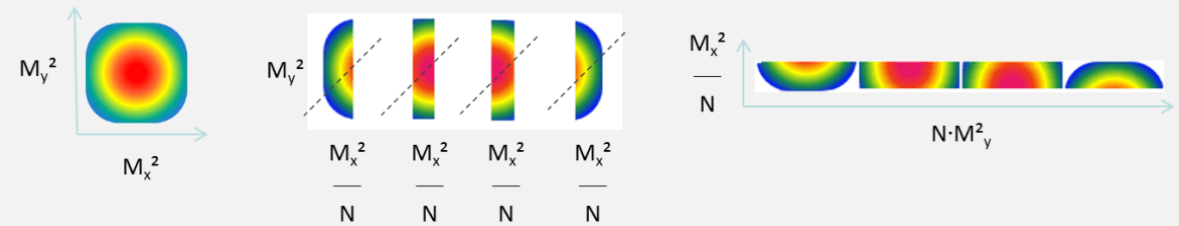







Symmetrical beam → High density line beam

Our UV-L750 System for Laser Lift-Off (LLO) was Prism Awards winner in 2018

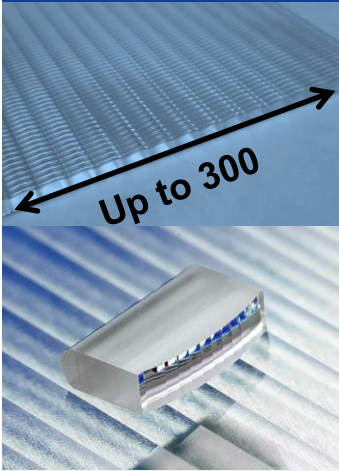
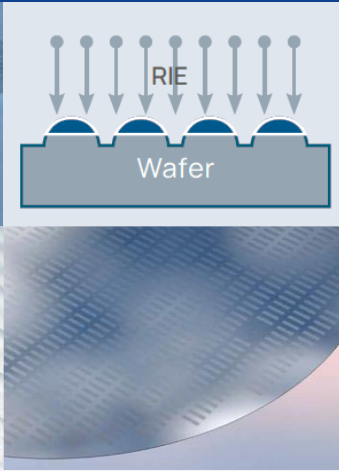
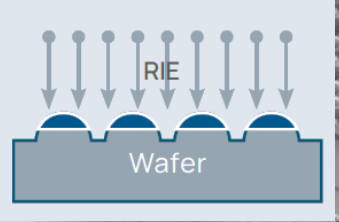
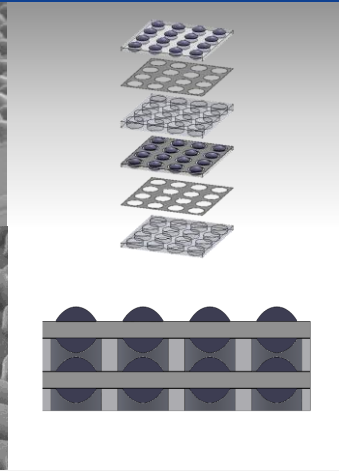
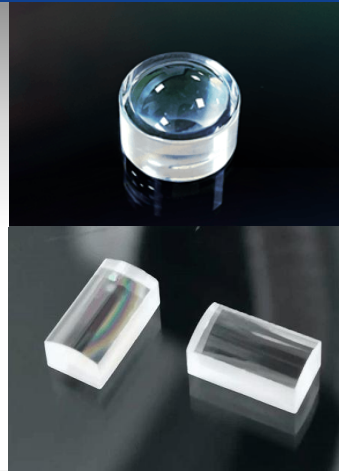

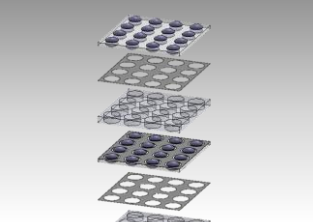
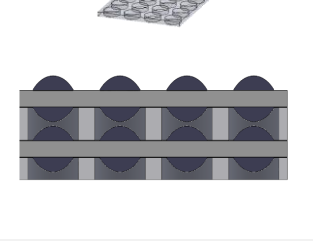
# Core Competence

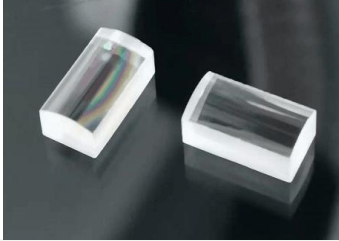
Optics Manufacturing

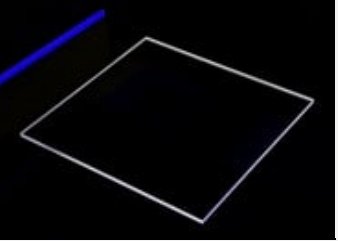
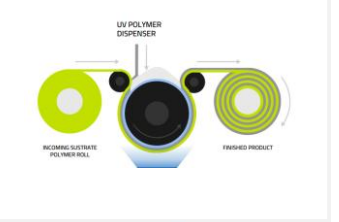
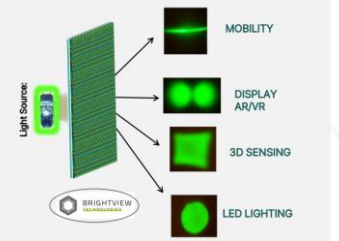
Wafer Level Simultaneous Structuring	Wafer Level Photolithography-RIE (reactive ion etching)	Wafer-Level Optics (WLO) Precision Imprinting	Wafer-Level Stacking (WLS)	Precision Glass Molding	Cold Processing	Roll to Roll
 	 	 	 	 	 	 
<p>With inorganic materials: Glass, Fused Silica, Silicon, CaF<sub>2</sub></p>		<p>With polymer on glass</p>		<p>With moldable Glass</p>	<p>With inorganic materials</p>	<p>From PET to PC to PMMA</p>
<p><b>High LIDT Optical Coating:</b> Anti-reflection, high-reflection, beam splitter, band filter, and various customization (UV, VIS, IR)</p>						

# Core Competence

Test, Analysis and Diagnosis

## Test and Characterization of High-Power Diode Laser

A comprehensive physical diagnostic model allows full characterization of a set of key parameters, such as:

- LIV
- Spectrum
- Polarization
- Far-field / Near-field
- Spatial spectrum
- Spatial polarization
- Spatial beam profile
- Smile effect
- Lifetime

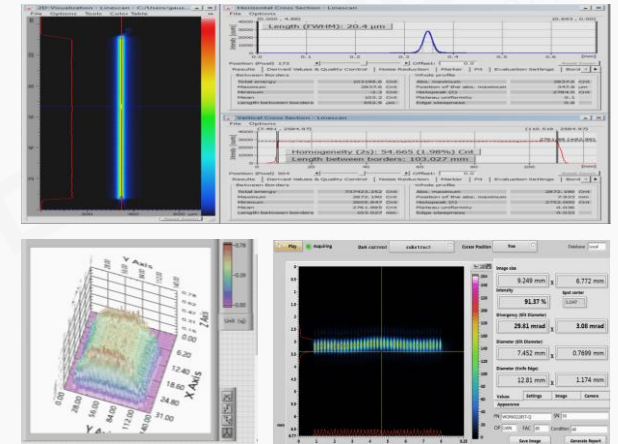

## Metrology and Analysis of Optical Components

Wave optics models are used in conjunction with tactile surface measurements for precise analysis of optical functions such as:

- Focusing
- Collimation quality
- Beam uniformity

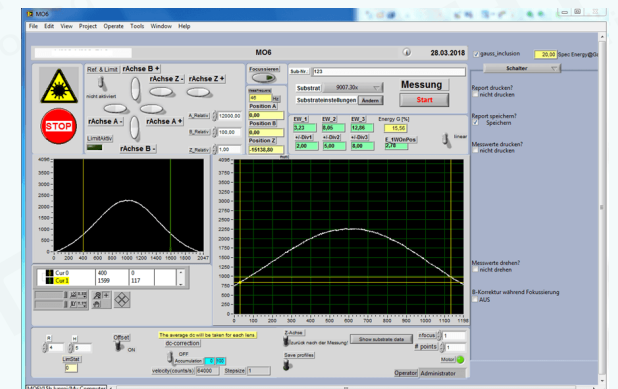

# Core Competence

High Precision Optical Assembling Process and In-house Equipment: From Components to Subsystems

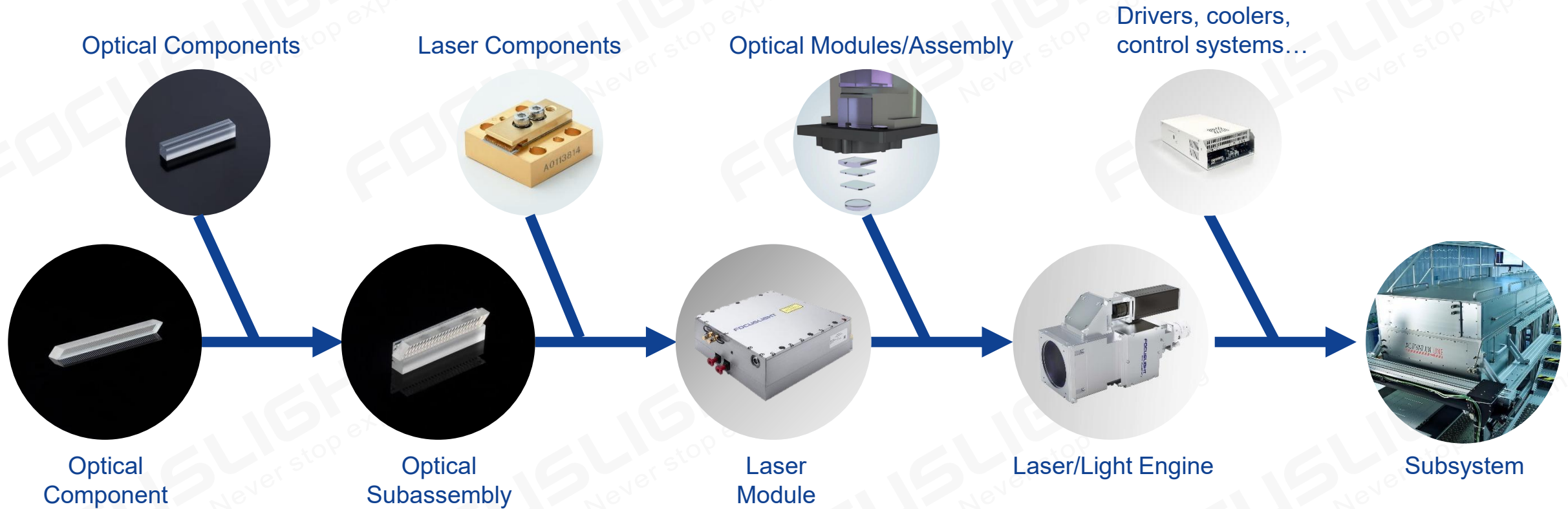

# A Unified Quality Management System

Governance Framework That Drives Enterprise-Wide Quality Excellence

ISO9001 Certified Quality Management System (QMS)

ISO14001 Certified Environmental Management System (EMS)

IATF16949 Certified Automotive Quality Management System

ISO45001 Certified Occupational Health and Safety Management System

Failure Mode and Effect Analysis (FMEA)

Statistical Process Control (SPC)

Production Traceability Database

Control Plan (CP)



# Quality Assurance System

Ensuring Product Reliability Through Rigorous Controls and Verification

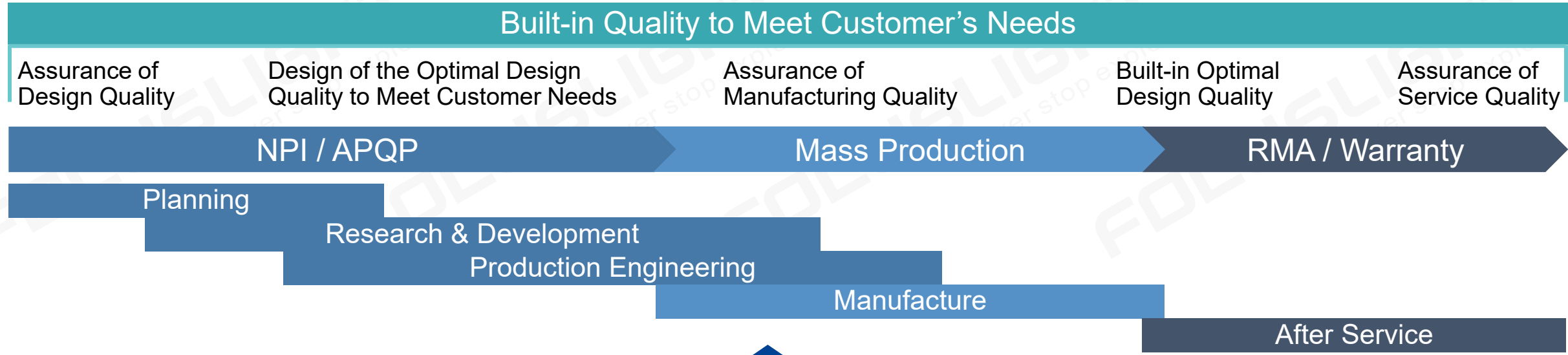

**Promotion of Consistent Quality Assurance Activities**

Quality Control System of Design	Quality Control System of Manufacture		Quality Control Evaluation System
<ul style="list-style-type: none"> <li>• QFD</li> <li>• Critical Characteristic, Special Characteristics</li> <li>• Tolerance Chain Design</li> <li>• FMEA, FTA</li> <li>• Design Validation</li> <li>• Design Review</li> </ul>	<ul style="list-style-type: none"> <li>• Parameter design</li> <li>• Process FMEA</li> <li>• Process Capability Study</li> <li>• Automatic Inspection,</li> <li>• Poka Yoke / Error Proof</li> <li>• Measurement System Analysis</li> </ul>	<ul style="list-style-type: none"> <li>• QA Network</li> <li>• Supplier Quality Management</li> <li>• Production Validation</li> <li>• Control Plan</li> <li>• QC Circles</li> <li>• Production Part Approval Process</li> </ul>	<ul style="list-style-type: none"> <li>• QC diagnosis</li> <li>• Quality assurance Meeting</li> <li>• Quality Auditing Improvement Meeting</li> </ul>

# Focuslight Manufacturing System (FLMS)

Building Stable, Efficient, and Scalable Production Capabilities

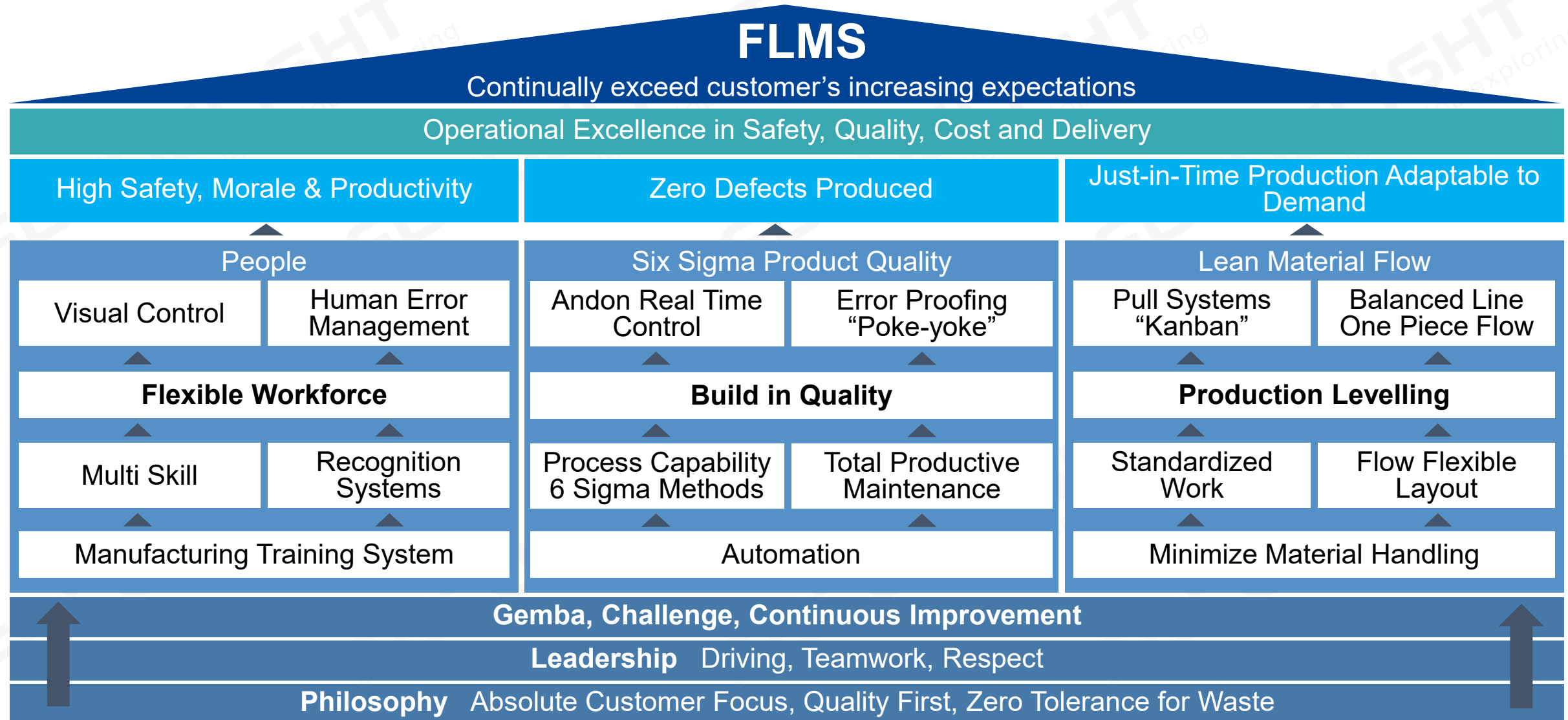

## To Build the Focuslight Global Manufacturing System

Zero Accidents

Zero Defects

100% Value Added

100% Delivery



**Local Manufacturing Ops**



**QCD-focused**

- Collaboration within sites
- Limited cross-site / cross-BU collaboration

**Global Manufacturing Ops**



**VSM improvement-focused**

- End-to-end value stream integration
- Building an efficient global manufacturing system

**Digital Manufacturing Ops**



**Data-driven decisions**

- Big data based cost modeling & decision support
- Global MES: automated data collection & analysis
- Predictive metrics, early warning, fast response

**Smart Manufacturing Ops**



**Self-optimizing manufacturing system**

- Replicable lean capabilities
- System evolution & self-healing
- Lean system scaling with new business growth
- Autonomous decision-making, healing, and response

Strategy Execution

Fast Response

Empower Team

Automation, Digitalization, Intelligentization

# Manufacturing Technology Engineering

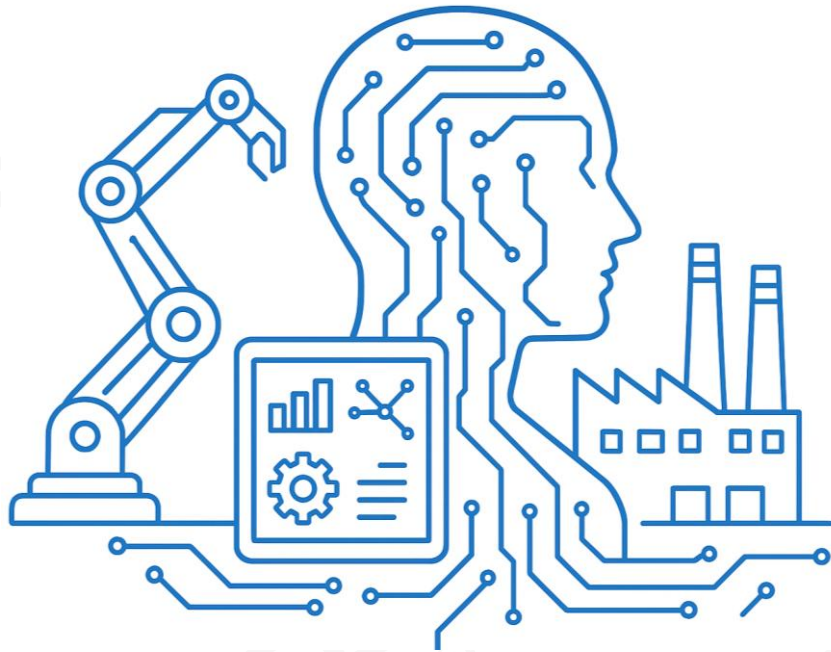

Equipment  
interconnection

## MES

- Improved efficiency
- Big data enhances quality through visibility

Big data boosts  
decision

## Testing

- AA (Active alignment)
- PA (Passive alignment)

## Automation

- AOI
- P&P (pick & place)
- CD (collaborative development)

# Automation Powered Operational Excellence

Automatic Optical Alignment

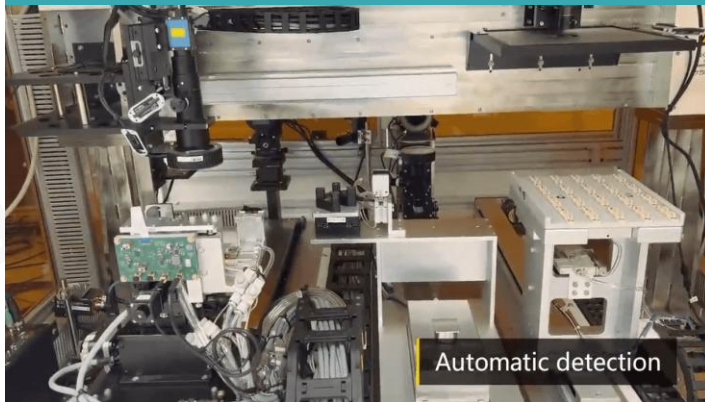

Automatic Assembly

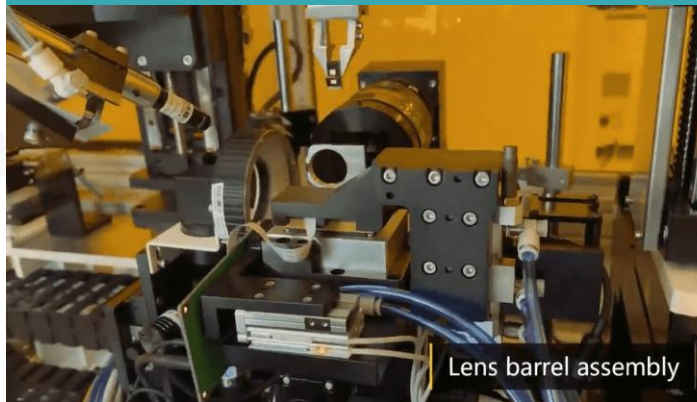

Automated Optical Inspection



Laser Optics Production Line



LiDAR Transmitter Production Line



Big Data Powered Production



Video Link: <https://www.focuslight.com/news-events/newslst/focuslight-autonotation-powered-manufacturing-excellence/>

# Manufacturing Capabilities

## Advanced Materials

10+ years high-volume manufacturing experiences + self-owned core technologies

DPC production



Etching production

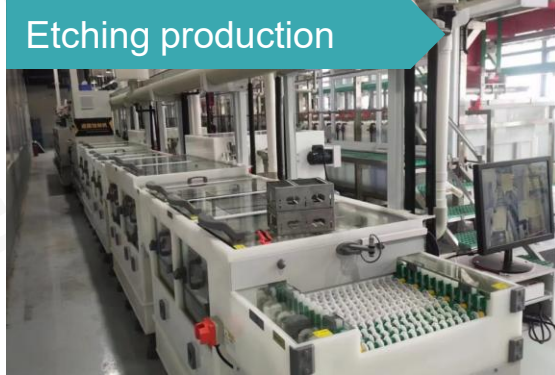

Au plating



Pattern production



Cleaning

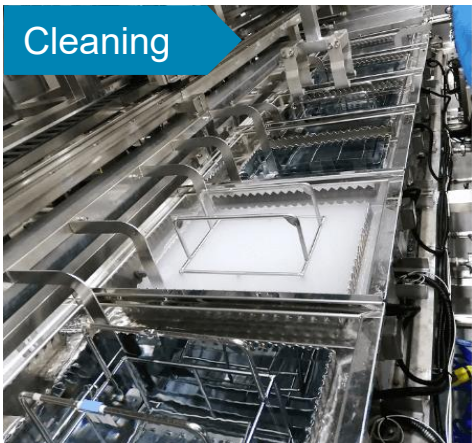

AuSn deposition



Laser marking



Dicing



AOI inspection



Advanced Materials Manufacturing Capacity > 2M pcs / month

# Manufacturing Capabilities

## Laser Sources

Packaging & Assembling



Optical Assembling



Testing & Measurement



Quality Inspection



Burn-in & Lifetime Test



Diode Laser Manufacturing Capacity > 500K pcs / year  
Burn-in Capacity 600K pcs / year

# Manufacturing Capabilities

## Micro-Optics: Wafer-Level Simultaneous Structuring Processing

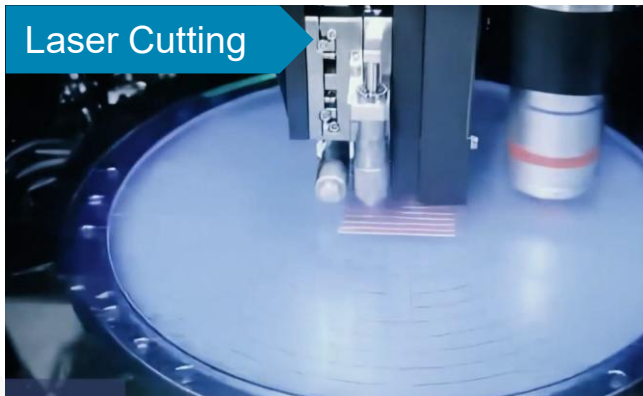
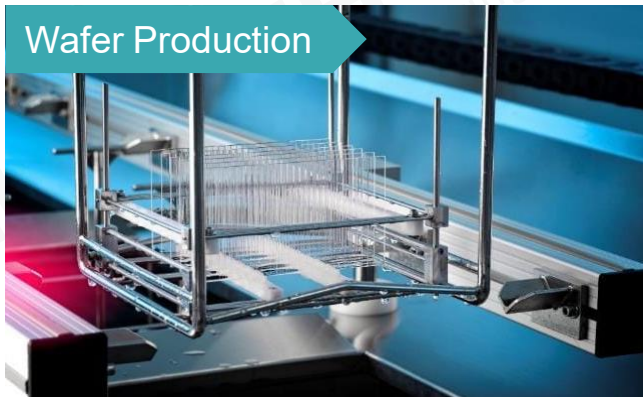

Wafer-Level Simultaneous Structuring Processing:  
Manufacturing Capacity > 2K wafers / month or > 5M pcs lenses / month

# Manufacturing Capabilities

## Micro-Optics: Photolithography-Reactive-Ion-Etching Processing

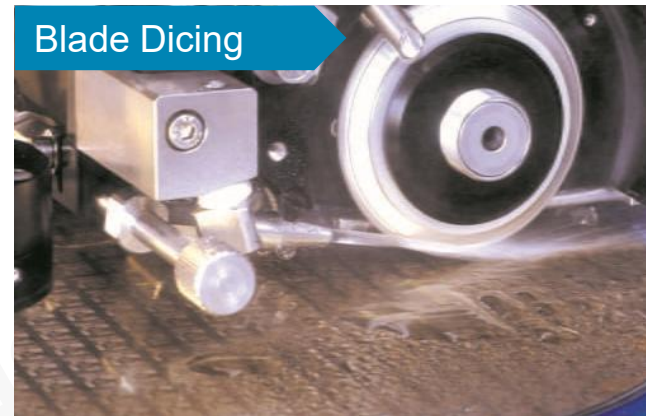
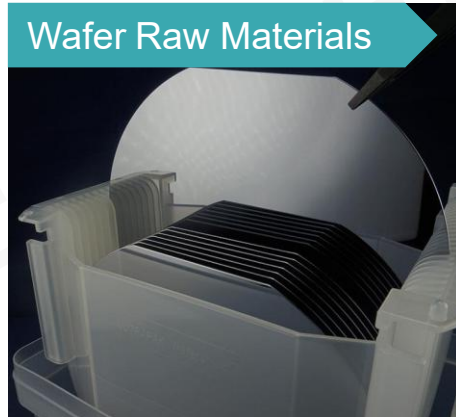

Photolithography-Reactive-Ion-Etching Processing:  
Manufacturing Capacity > 300 wafers / month

# Manufacturing Capabilities

## Micro-Optics: Imprinting Processing

Mastering

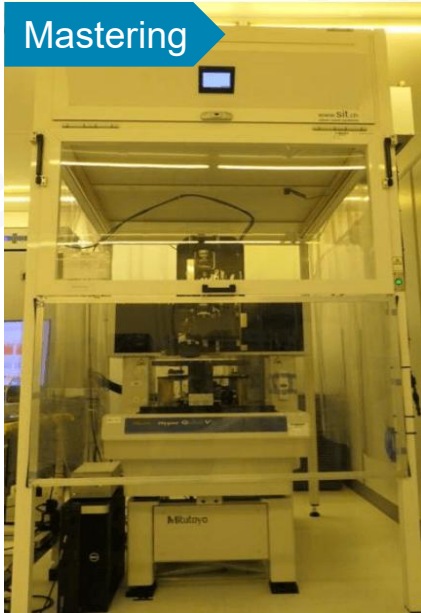

Replication



Stacking



Testing



Singulation



Imprinting Processing:  
Manufacturing Capacity > 2K wafers / month or > 8M pcs lenses / month

# Manufacturing Capabilities

## Micro-Optics: Precision Molding

Ultra-precision In-house Mold Making



Pressing / Molding



Coating



End Products



Barrel lens

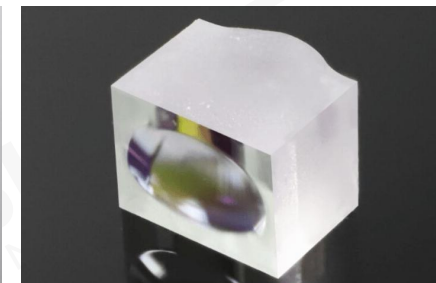

Bi-conic lens

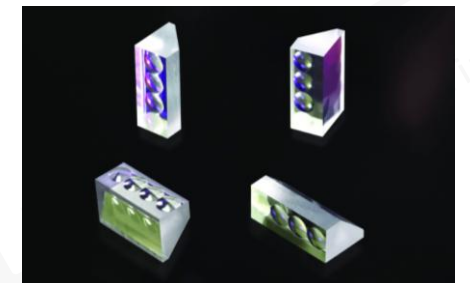

Microprism lens array

Precision Molding: Manufacturing Capacity > 2M pcs lenses / month

# Manufacturing Capabilities



BRIGHTVIEW  
TECHNOLOGIES



FOCUSLIGHT  
Never stop exploring

## Micro-Optics: Roll to Roll

### AI Software Design

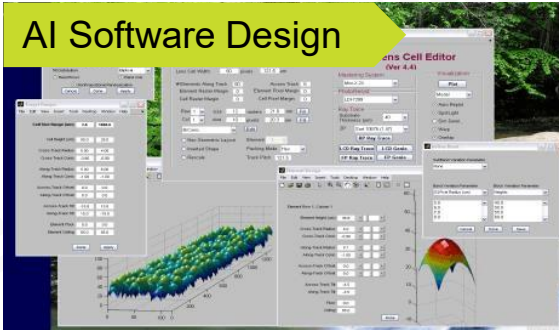

**Multi-function, complex designs** that can combine spatially variable shapes, structures, and densities in a single device creating a near infinite design space

### Mastering



The software transfers the design to BrightView's custom **large format (4'x8')** grayscale photolithography digital tooling system

Each pixel is "written" individually

Full size master can be written in under 24 hours

### Tooling

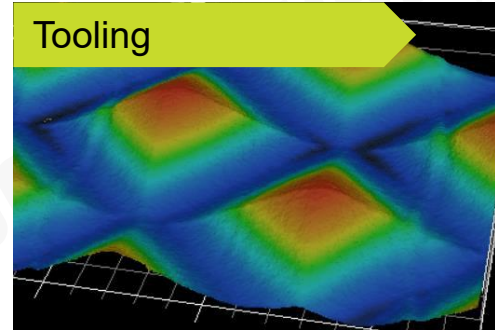

Exceptionally consistent, low cost, high fidelity, large format consumable tooling is created from the master (or a 3rd party master)

### Mass Production



A high-volume, continuous, roll-to-roll clean room manufacture of products on a variety of substrates from PET to PC to PMMA in a range of thicknesses using in-house formulated resin options

# Typical Applications

## Optical Communication

- High precision micro-optics are at the heart of optical communication systems.
- They support efficient data transfer between key optical components.

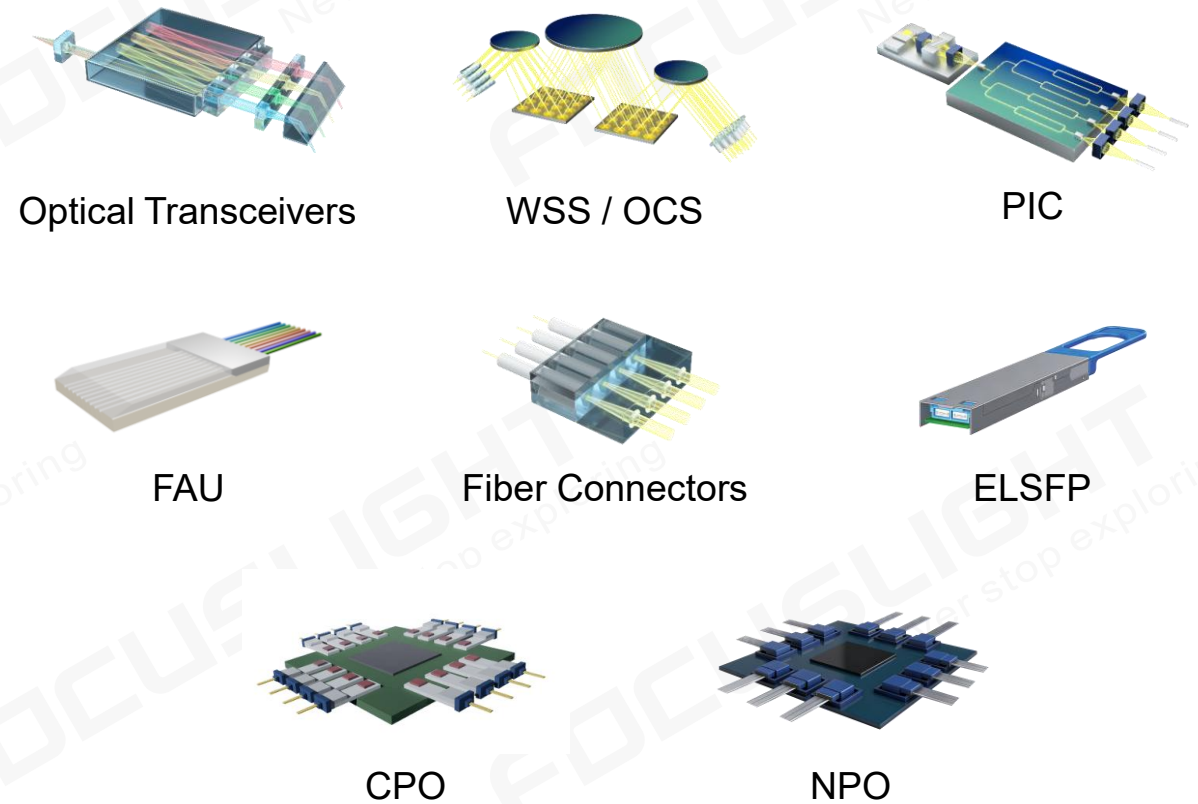
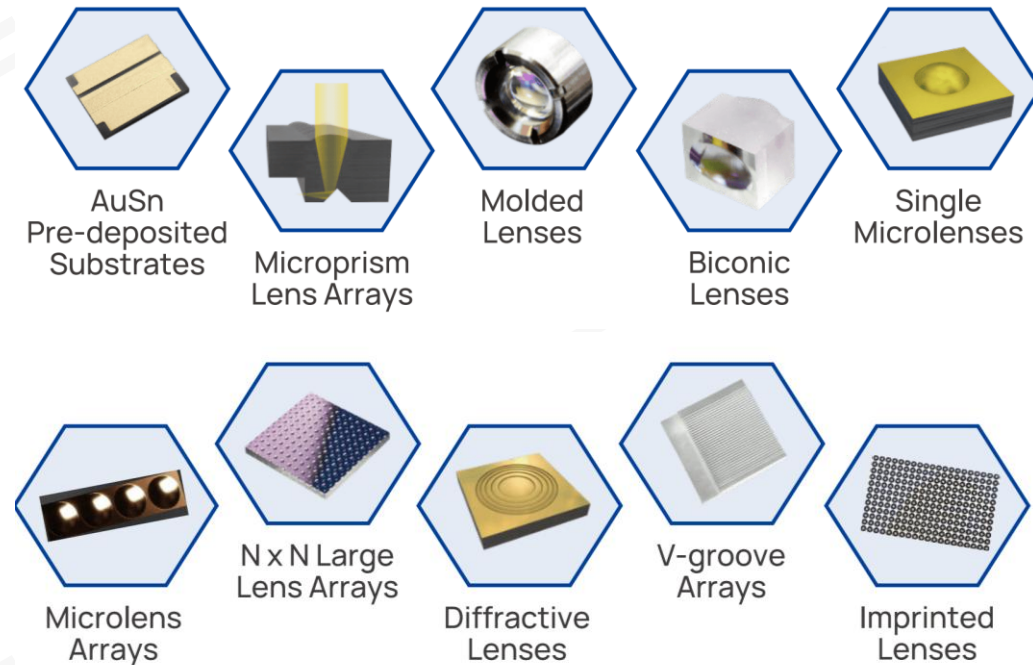

# Typical Applications

## Consumer Electronics



### Optical Sensing, Empowering AR/VR and AI to See

Multi-aperture wafer-level optical lens for AR-Light Engine

Micro-optics Modules for Vis & NiR solutions with multiple FoV options

Wafer level stacking that is fully reflowable and thus mass manufacturable

Leading thermal performance, ensuring simple thermal design

Face recognition, under-display face recognition

Complex micro dot projectors optics

Multi-Zone 3D sensor solutions, including dToF, Proximity sensor optics

Leading thermal performance, ensuring simple thermal design

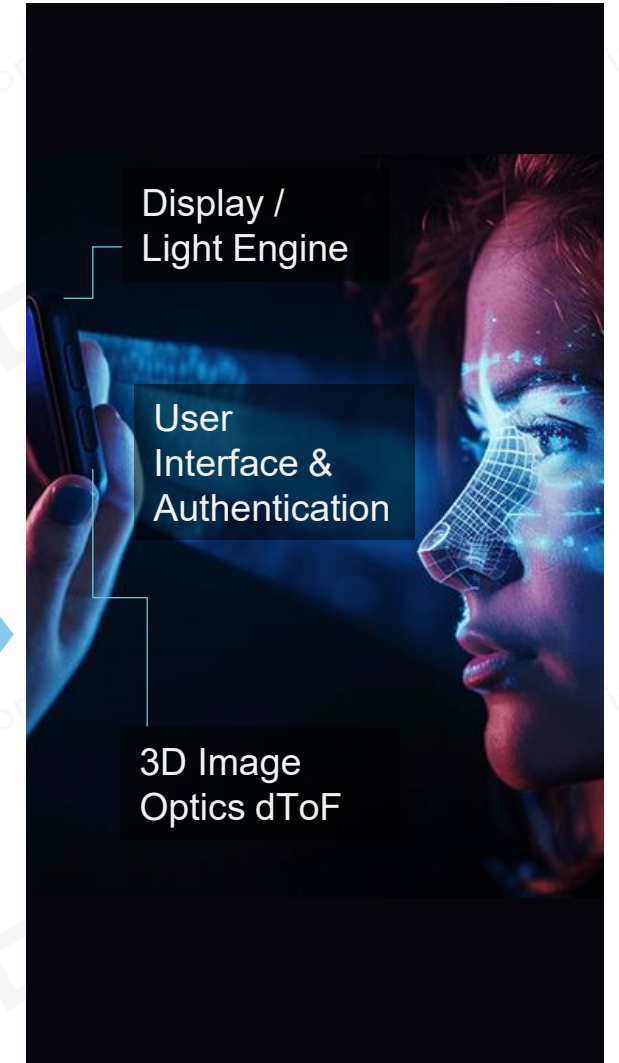

# Typical Applications

## Semiconductor

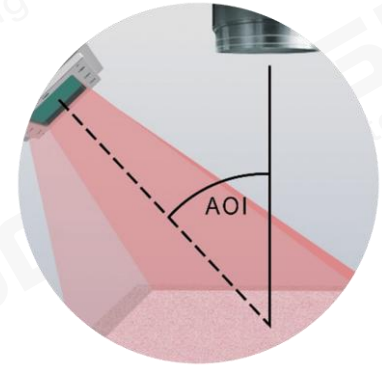
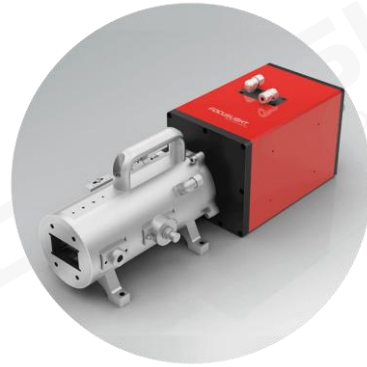

- Beam homogenization technology powers the illumination system – key optical component in **pan-semiconductor systems**
- > 15 years supply to the major manufacturer of semiconductor lithography tools

- Laser system solutions with high power density and different beam profiles, designed for various **laser-based wafer annealing processes** including IGBT backside annealing and SiC annealing

- Based on 976nm diode laser with adjustable beam output and >95% homogenization in energy distribution
- Ideal for **advanced chip packaging processes**, e.g. laser-assisted bonding

- Off-axis beam shaping technology powers laser surface treatment as well as surface inspection
- Typically used in **solar cell industry**

# Typical Applications

## Display Manufacturing



### Solid-State Laser Lift-Off (LLO) for Flexible Displays

- Several tens of beam shapers (plasma display pixel structuring)
- Several green 100 mm line beam systems (laser lift-off)
- > 600 mm UV line beam production system (laser lift-off)

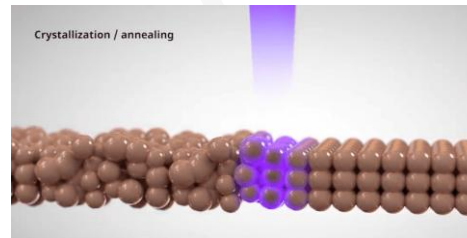

### Next-gen LTPS Solid-state Laser Annealing Process

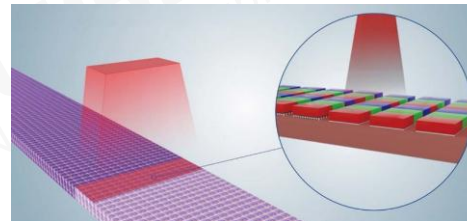

### Mini and Micro LED Processing

- Laser Mass Transfer and Laser Mass Soldering
- Laser Chip Repair

# Typical Applications

## Automotive

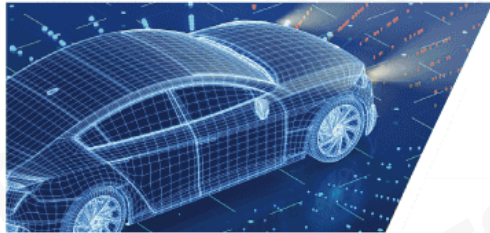

**LiDAR**



**Driver Monitoring System**



**Smart Headlight**



**Projected Lighting**



**AR HUD**



Optical Components  
and Assemblies



Laser Transmitter /  
Illumination Modules



*Focuslight does not  
produce LiDAR /  
Lighting full system*

# Typical Applications

## Medical and Health



Hair Removal



Body Sculpting

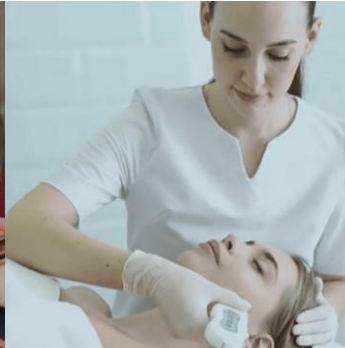

Skin Rejuvenation



Ophthalmology



3D Interoral Scanning



Dermatology

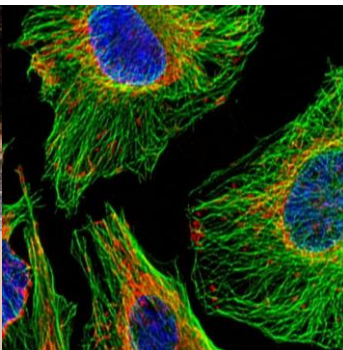

Confocal Microscopy

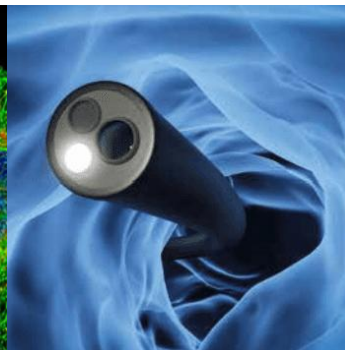

Endoscopy



Sensing



Laser Surgery



Optical Components;  
Laser Components



Optical Solutions;  
Laser+Optics Assembly;  
Application Handpiece



Contract Manufacturing  
Services



*Focuslight does not  
produce medical or  
health equipment*

# Typical Applications

## Industrial

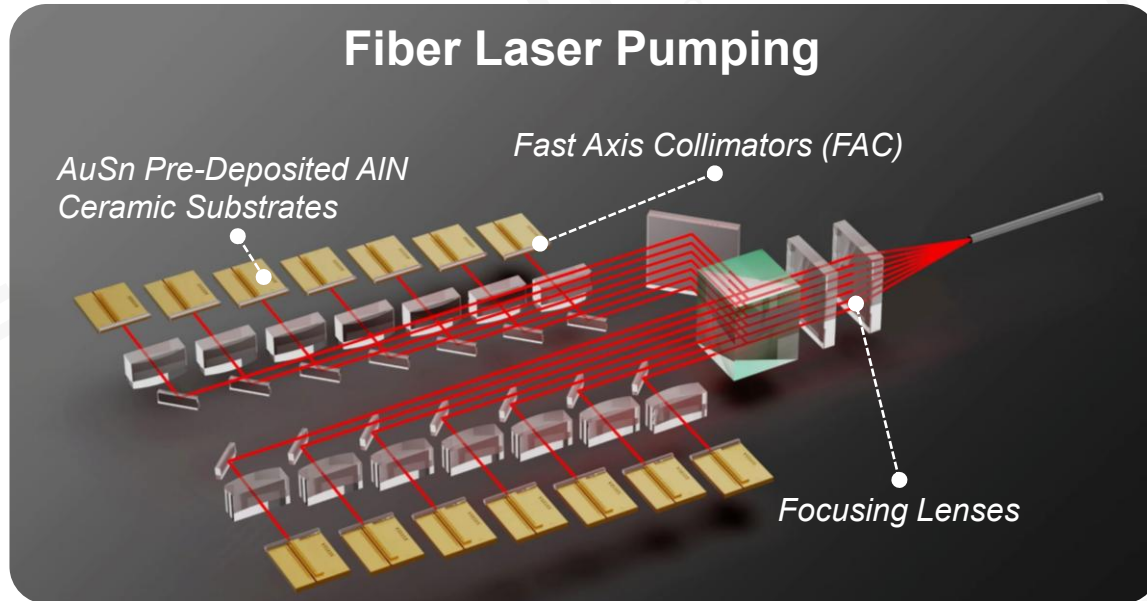

- **AuSn pre-deposited ceramic substrates** – stable and reliable thanks to the high thermal conductivity and suitable thermal expansion coefficient;
- **Fast axis collimators (FAC)** – fundamental and efficient solutions for shaping the beam emitted by the pumping sources;
- **Focusing lenses** – coupling the collimated laser beam precisely into the output fiber;

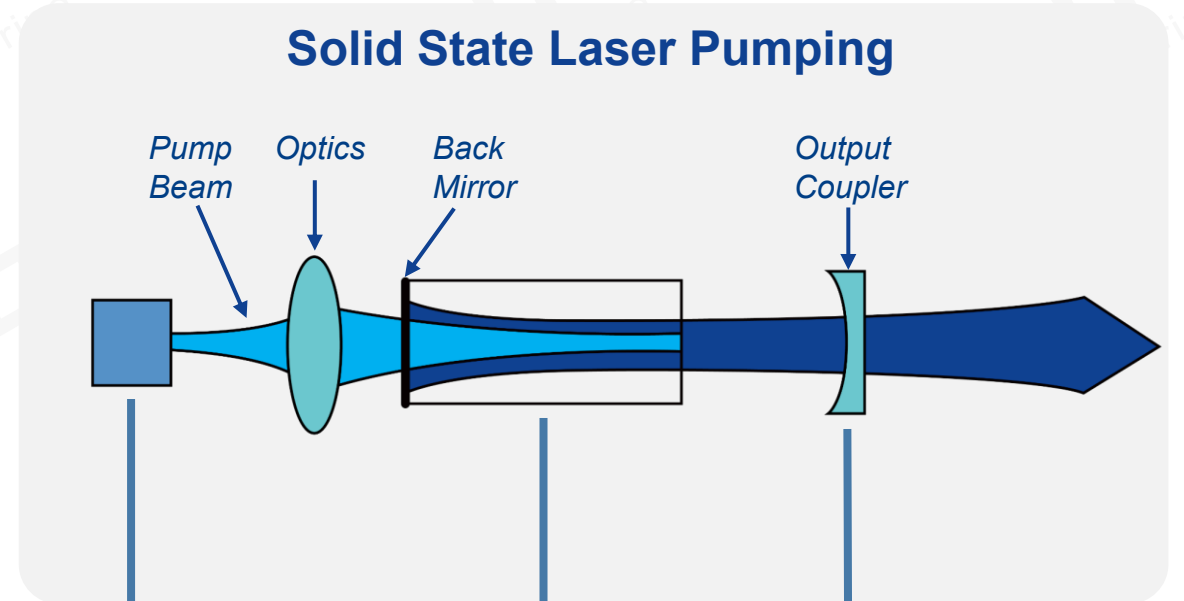

Diode Laser as Pumping Source

+

Gain Medium

+

Optical System

Footprint ↓

Reliability ↑

Efficiency ↑

Cost ↓

# Typical Applications



BRIGHTVIEW  
TECHNOLOGIES



FOCUSLIGHT  
Never stop exploring

## Advanced Display

Advanced displays must support **power hungry AI/video processors** while providing **high brightness, superb color rendering, and excellent image rendering.**

### Challenges and Demands

- Use a passive mechanism to increase brightness
- Cost effective for consumers
- Increase display performance (color, uniformity, resolution)
- Thin, flexible, lightweight for portability
- Withstand range of environmental conditions
- Improve sustainability with thin, multi-function films

### BrightView Computational Optics solutions

- **Display Enhancement Films:** Demonstrated up to 40% increase in brightness translating to 60-120 minutes of additional battery life
- **Zonal Films:** Gradient of micro lenses to correct color non-uniformity while maintaining brightness and HDR



# Typical Applications

## Lighting



BRIGHTVIEW  
TECHNOLOGIES



FOCUSLIGHT  
Never stop exploring



Indoor Commercial



Indoor Architectural



Outdoor Architectural

BrightView engineered **diffusers** and **microlens arrays** enhance lighting performance by improving light control, efficiency, uniformity, and visual comfort.



Parking Garage



Stage Lighting



Horticulture

# Sales Network

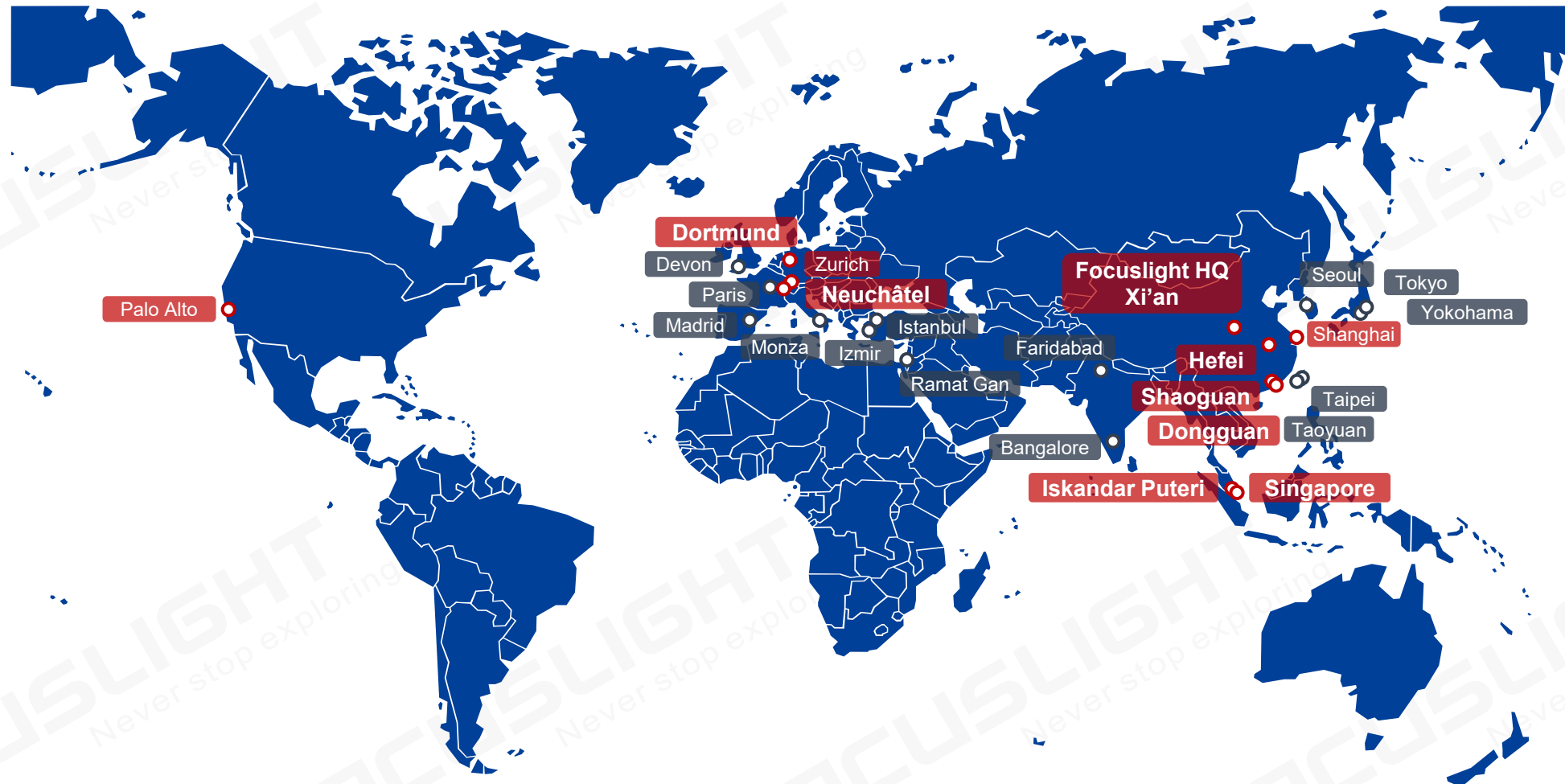

- Worldwide established distributors
- Direct sales offices in China, Switzerland and US
- R&D and operation centers in China, Germany, Switzerland, Singapore; Malaysia operation center being constructed

## Your committed and reliable long-term partner in photonics components and solutions



Diode laser light source leader and beam shaping expert with strong IP position



One-stop-shop provider of micro-optics choosing from five process technologies best matching customer needs



Global photonics foundry that convert customers' ideas and designs into their own products and solutions



Total solution, versatile customization service and field service provider



Strong RDE capability, high volume production capacity and low-cost manufacturing



Financially healthy and strong financial backing from investors for long term growth

# THANK YOU



[www.focuslight.com](http://www.focuslight.com)

[www.hptg.com](http://www.hptg.com)

