

Focuslight Corporate Overview

© Focuslight Technologies Inc.

2025-02

Focuslight Overview

- Founded in 2007 by Dr. Victor X. Liu, headquartered in Xi'an, China.
- A fast-growing company that develops and manufactures:
 - **High-power diode laser components and materials** (Photon Generation)
 - **Laser optics components** (Photon Control)
 - **Photonics module and system solutions** (Application Solutions) focusing on optical communication, automotive, pan-semiconductor, and medical and health applications.
- A **global photonics foundry** offering process development and manufacturing services to the global photonics community.
- Publicly listed in the Shanghai Stock Exchange (Ticker Symbol: 688167).



Milestones

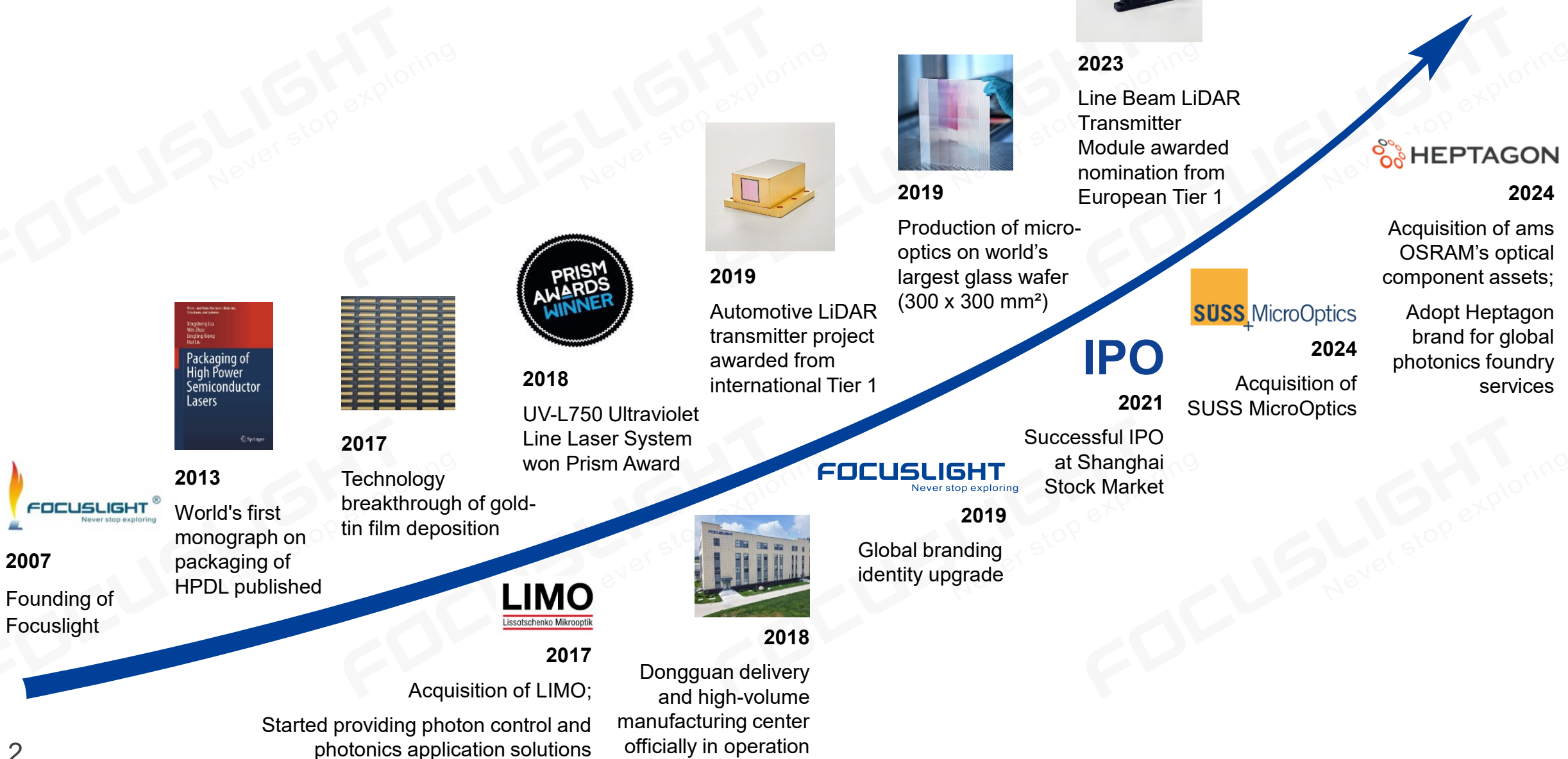

Focuslight Corporate and Subsidiaries

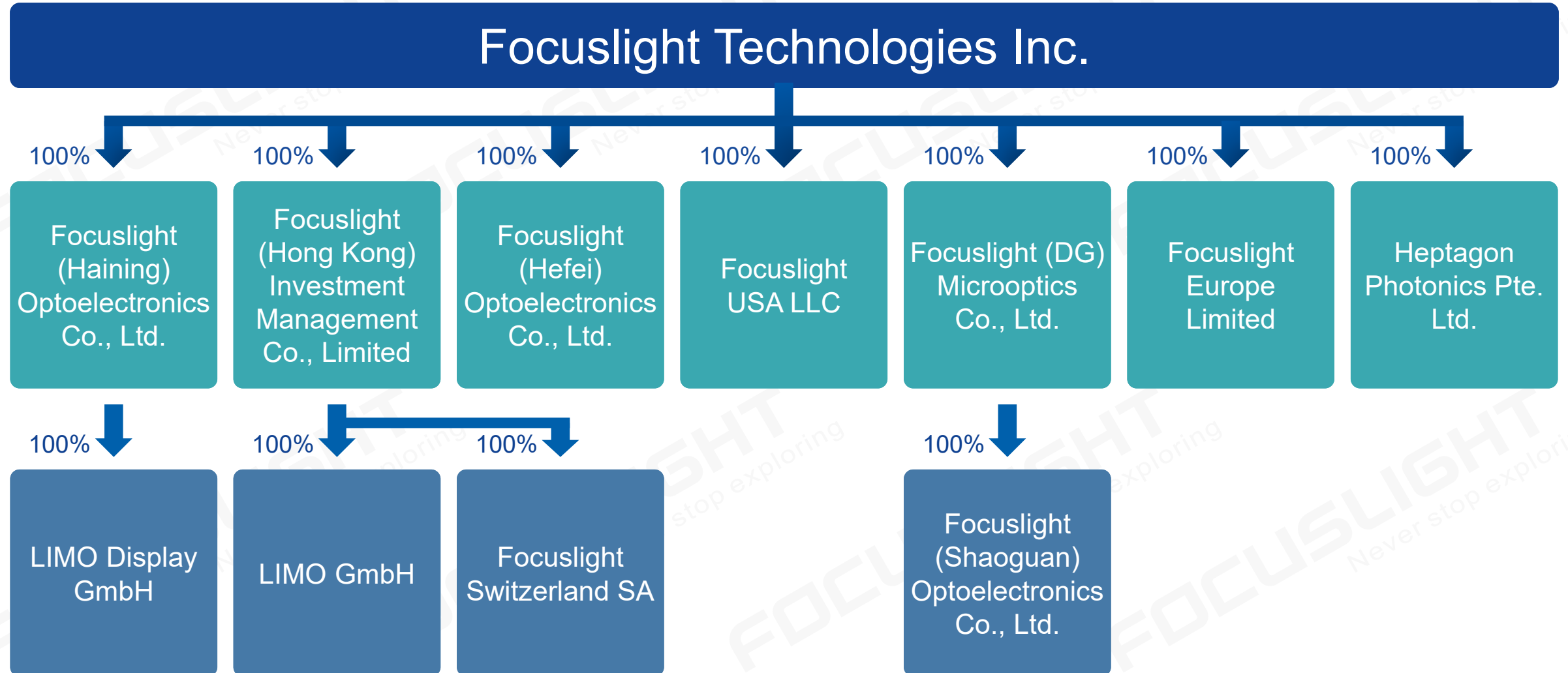

Focuslight Global Operations System

Leverage the strengths and capabilities of each location to **cater to specific customer demands** and **optimize operational efficiency**.

Through centralized decision-making, integrated operations, and lean management, a **high-efficiency, low-cost global operations system** is established.



Neuchâtel, Switzerland
Operations Center



Dortmund, Germany
Operations Center



Xi'an, China
Focuslight HQ, Operations Center



Haining, China
Hefei, China
Operations Center
(being constructed)

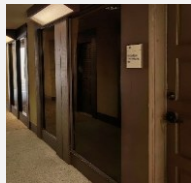

Silicon Valley, USA
Innovation Lab



Zurich, Switzerland
R&D Office



Ang Mo Kio (AMK), Singapore
Operations Center
Business Center

Other Southeast Asian regions
(to be decided)
Photonics Foundry



Shaoguan, China
Operations Center



Dongguan, China
Operations Center

Key Facts & Figures



Employees

>900



Yearly Revenue Proportion
Invested into R&D

~16%



Yearly Revenue
(2023)

561M RMB



Patents Valid
Worldwide

>610



Facility Worldwide

>48,000m²

Clean Room Worldwide

>14,000m²

























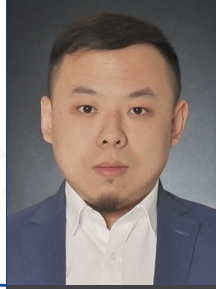



ISO 9001
ISO 14001
ISO 45001
IATF 16949
Certified

Corporate Management Team

 <p>Dr. Xingsheng Liu (Victor) Chairman, CEO</p> <p>Research and management experience in the US, with 100+ publications, 300+ patents, 30+ invited papers internationally</p> <p>Committee Member of SPIE and IEEE</p> <p>CORNING COHERENT nLIGHT</p>	 <p>Dr. Chung-En Zah CTO</p> <p>30+ years of research experience in the US, with 300+ publications, 50+ patents in optoelectronics and telecommunication</p> <p>IEEE Fellow, OSA Fellow, 2x R&D 100 award winner</p> <p>THORLABS CORNING Bellcore <small>Communications Research</small></p>	 <p>Dr. Reinhard Voelkel Chief Strategy Officer</p> <p>35+ years of professional experience in the field of micro-optics, with expertise in strategic leadership, business development, and innovation</p> <p>SUSS MicroOptics unine <small>Universität de Neuchâtel</small> FAU <small>FRIEDRICH-ALEXANDER UNIVERSITÄT ERLANGEN-NÜRNBERG</small> Sand Hill Angels</p>
 <p>Mr. Sinclair Vass Corporate SVP of International Sales & Business Development</p> <p>35+ years experience in international photonics markets, having held technical, commercial and general management leadership roles at major multinational companies</p> <p>Velodyne JDSU Lucent Technologies <small>Bell Labs innovations</small> hp</p>	 <p>Mr. Guowei Zhu (Gavin) Corporate VP of Quality, President of Automotive BU</p> <p>20+ years in international automotive companies, rich experience in IATF QMS and plant operations management by World Class Manufacturing (WCM) & Lean manufacturing</p> <p>MAGNETI MARELLI BorgWarner GST <small>SEYON AUTOLEATHER</small></p>	 <p>Mr. Tan Chee Huo (Michael) Corporate SVP of Business Process and IT</p> <p>25+ years in IT leadership, specializes in digital business transformation, global project management, multicultural team leadership in fast-paced international industries, and strategic decision-making</p> <p>NOKIA ThermoFisher Tupperware EVIDENT <small>SCIENTIFIC</small></p>
 <p>Mr. Ye Dai (Robert) Corporate VP of Global Sales</p> <p>Excellent track record in worldwide sales, product line and business unit management leadership roles</p> <p>20+ patents granted</p> <p>IVO APPLIED MATERIALS</p>	 <p>Ms. Yiping Ye (Alison) Board Director, CFO</p> <p>Over 15 years management experience and multi-field business practices</p> <p>In-depth understanding in LTC, IPD, intercultural cooperation and rich operational experience in market development, project operation and business management</p> <p>HUAWEI Hanergy <small>汉能</small></p>	 <p>Mr. Qichuan Yu Chief Product/Process Officer</p> <p>Over 25 years of experience in wafer-level optics, optical sensor and camera packaging, SAW/BAW filter R&D, and NPD execution, with a strong focus on mastering, tooling, and wafer-level processes</p> <p>amul OSRAM HEPTAGON EPCOS</p>

Corporate Management Team

	<p>Ms. Xuefeng Zhang (Jennifer) Board Secretary, Marketing Director</p> <p>14 years photonics industry international business experience</p> <p>In-depth understanding and rich experience in sales, marketing and business development</p> <p> </p>		<p>Mr. Jian Zhang (Lucas) Director of Global Operations Centers</p> <p>20 years of global supply chain management experience at multiple Fortune 500 companies, with strong expertise in supply chain planning and management within the consumer electronics industry</p> <p>  </p>
	<p>Mr. Jinchao Qu President of Diode Laser BU, President of Medical & Health BU</p> <p>Extensive years of product marketing and sales management experience</p> <p>Outstanding track record in previous roles as Asia Sales Director and Head of the Application Systems Special Task Force</p> <p> </p>		<p>Mr. Dirk Walter Bogs President of Laser Optics BU</p> <p>Over 25 years' experience in ultra-precision tooling, optic manufacturing, engineering & project management, and operational management</p> <p>Very deep knowledge of technology development and optimization</p> <p> <small>A Focuslight Company</small></p>
	<p>Mr. Yong Tian (York) VP of Laser Optics BU</p> <p>20+ years of operation & R&D management, very deep knowledge with organic optical materials and optical coating technology, published SCI articles and owns patented technologies</p> <p>Experienced in Lean Manufacturing & Industry 4.0</p> <p> </p>		<p>Mr. Weiyi Gu President of Pan-Semiconductor Solutions BU</p> <p>12 years experience in photonics R&D and product management, with rich track records of leaderships in developing and delivering system solutions for pan-semiconductor and industrial applications</p> <p> <small>Never stop exploring</small></p>
	<p>Dr. Tobias Senn Vice President of Strategic Growth Division</p> <p>15+ years of experience in micro-optical component development for the consumer market. Expert in design for manufacturing and process development, with a strong focus on high-volume production and yield improvement</p> <p>   </p>		<p>Mr. Hongyuan Liu (Tom) President of Global Photonics Foundry BU</p> <p>20+ years in R&D and operations management, specializing in optical imaging and non-imaging system design, WLO process & integration, and optical component manufacturing. Proven track record in new product development and scaling high-volume production</p> <p>   </p>

Products and Businesses

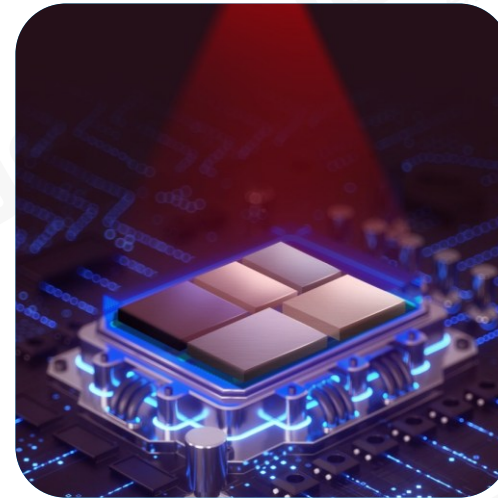
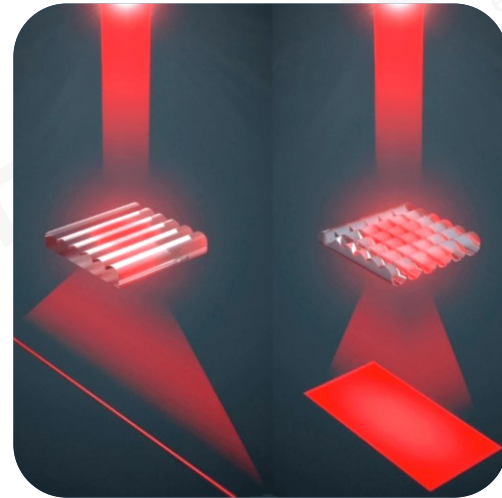
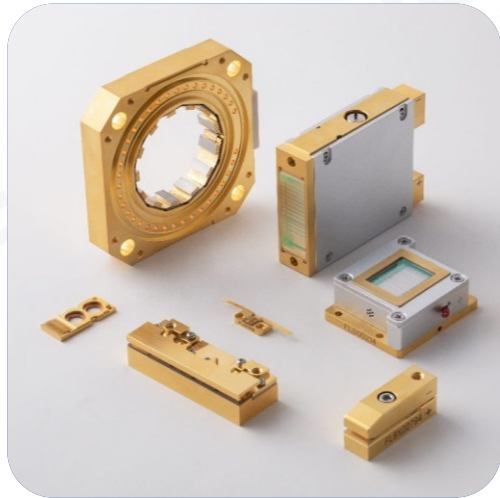

Photon
Generation



Photon
Control



Photonics
Application
Solutions



Global
Photonics
Foundry

Markets

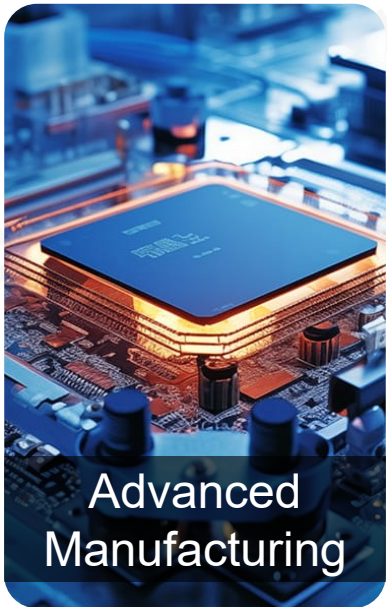

64%
revenue

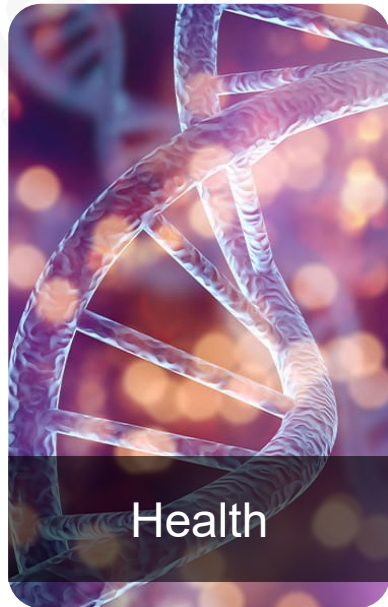

12%
revenue



4%
revenue



15%
revenue

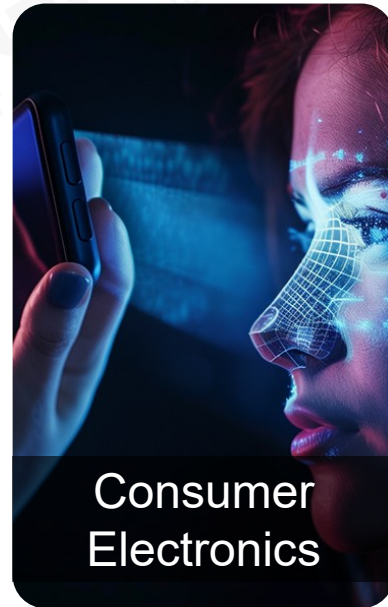

1%
revenue

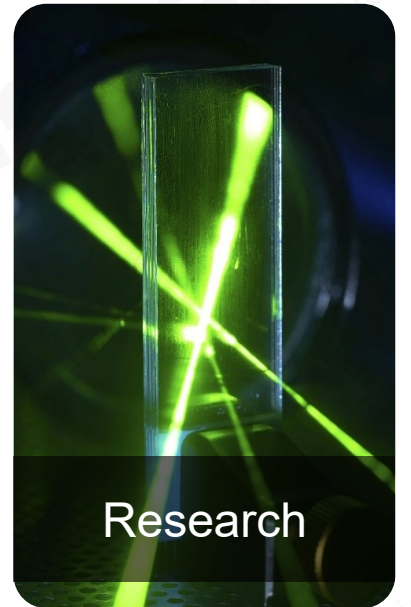

4%
revenue

** Based on accumulated revenue data from 2024 Q1 – Q3*

Value Proposition

Total Solution and Service in Full Value Chain

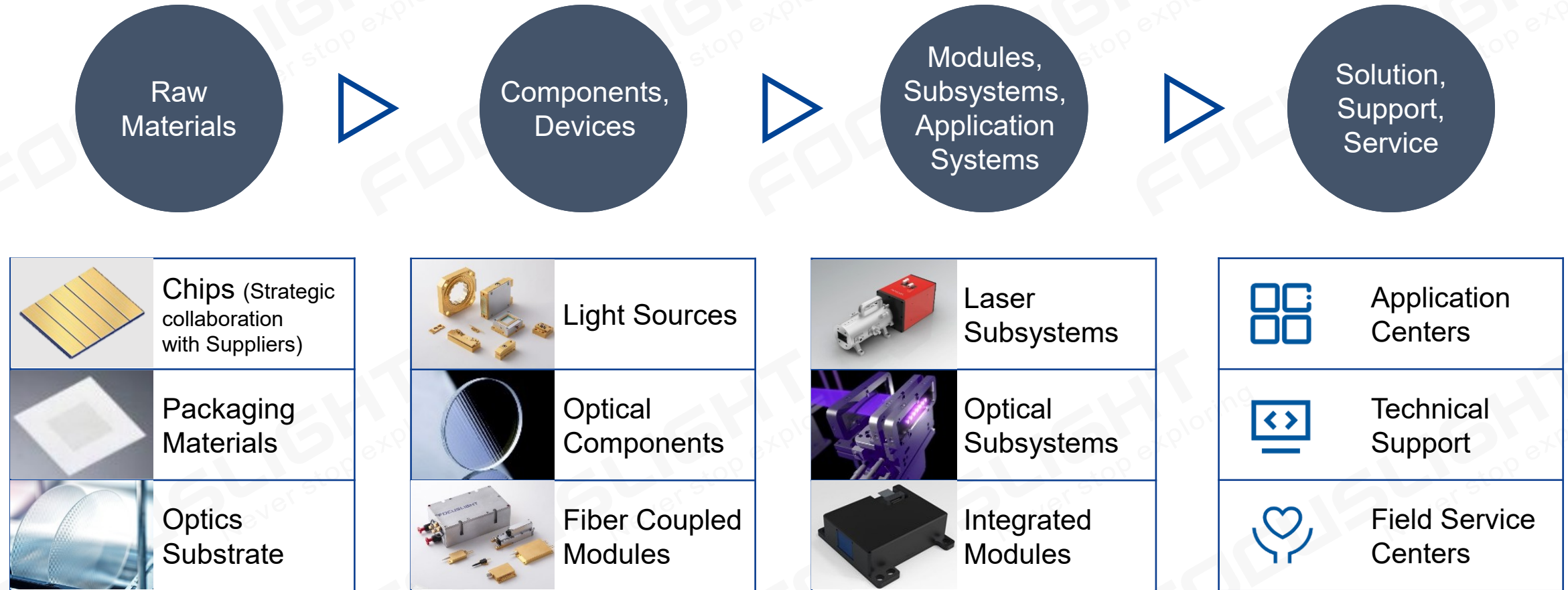

Industry Leader + Strong Financial Backing + Healthy Stable Company + Invest in the Future



Do what we do best

Offer the best value

Optimize to the extreme

Achieve the best
performance / quality-to-
price ratio

Commitment to Customers

- Lowest cost manufacturing for high volume products
- Willing to take technical risk, but need customer to commit market
- Willing to take investment risk in R&D and capital including M&A for customer on the condition of customer commitment of market share
- Collaboration transparency, fast response, IP protection and long-term partnership



What we don't do

Take high market risk

Being greedy

Being too aggressive

Compete against customers

Vision

FOCUSLIGHT
Never stop exploring

**To unlock the potential
of photonics to
enhance and enrich
people's life**



Mission

FOCUSLIGHT
Never stop exploring



Be the global trusted
photonics solution provider
through innovation,
manufacturing excellence
and fast response

FOCUSLIGHT
Never stop exploring

All Focuslight-designed products and business lines will be marketed globally under the Focuslight brand to streamline operations and create synergies.

 **HEPTAGON**

Foundry services that convert customers' ideas and designs into their own products and solutions will be marketed under the Heptagon brand.

Focuslight Technologies

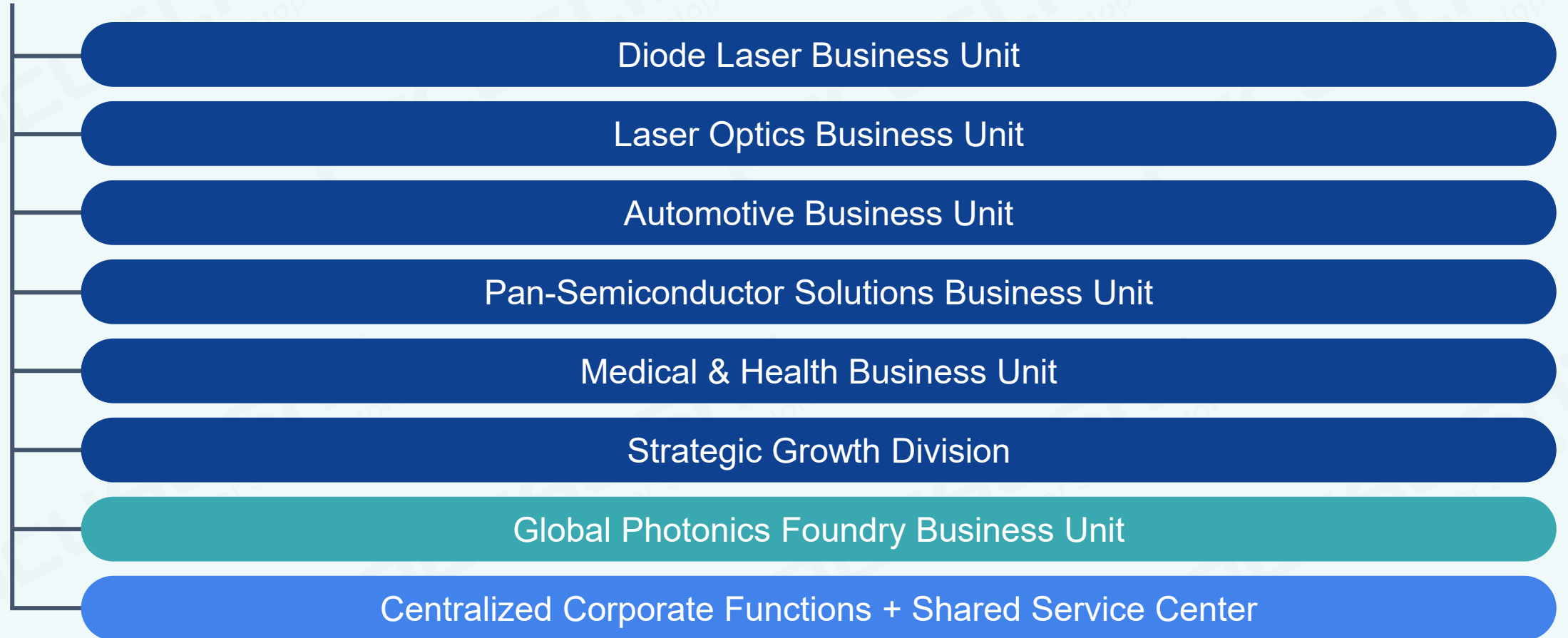

Products - Diode Laser Components

Under Focuslight Brand

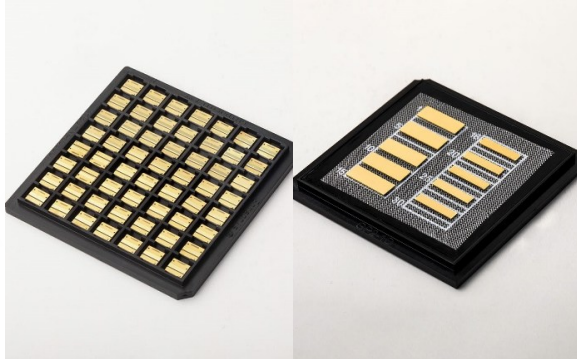

Advanced Materials

- AuSn Pre-Deposited AlN Ceramic Submounts
- AuSn Pre-Deposited CuW Submounts
- Thin Film Metallization Service



Active Devices

- Single Emitter Components
- Single Bar Components
- Micro-Channel Cooled Stacks
- Conduction Cooled Stacks
- Pumped Modules

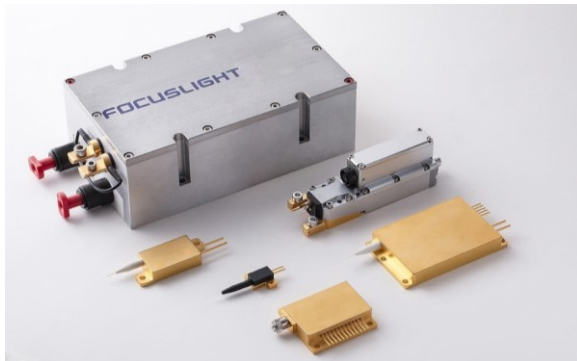

Fiber Coupled Modules

- Emitter-Based FCM
- Bar-Based FCM



Professional Medical Application Components

- Laser Hair Removal Engines

Products - Laser Optics Components

Under Focuslight Brand

Single Lenses and Linear Lens Arrays



FAC



SAC

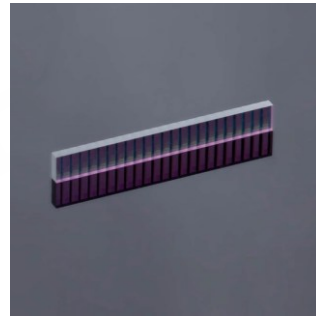

SAC array



BTS

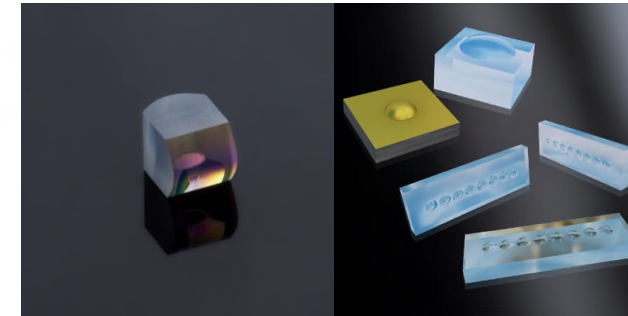

Fiber coupler and collimator

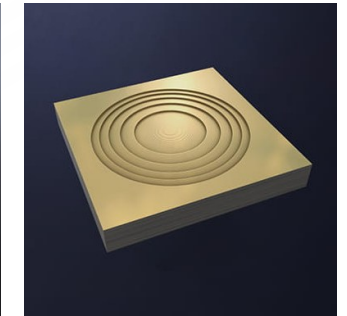

Collimating DOE

Area Lens Arrays

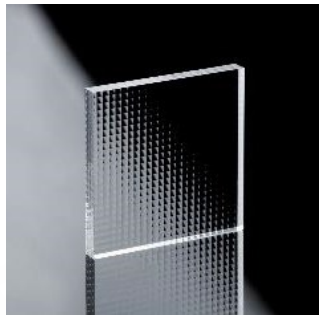

Homogenizer and diffuser

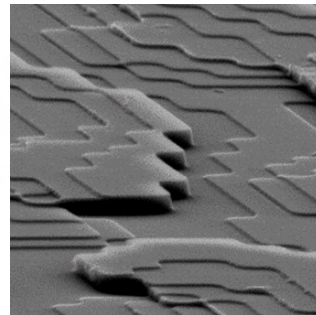

DOE beam splitter, dot or line generator



Shack-Hartmann array

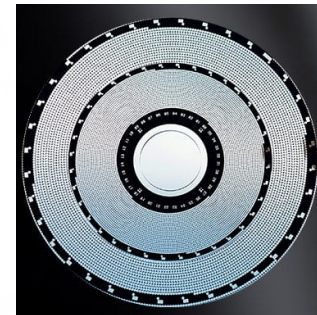

Pinhole array

Plano Optics and Coatings



Micro prism

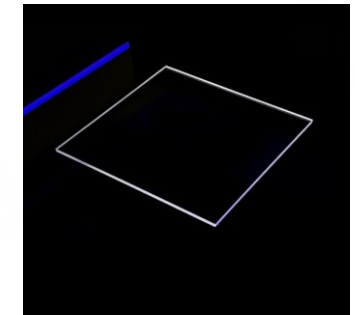

Window

Products - Automotive Application Solutions

Under Focuslight Brand

Flash LiDAR Transmitter Modules

AX02 Pro (Engineering Sample)



VCSEL Flash Transmitter 700W

Line Beam LiDAR Transmitter Modules

LE02 Pro (Engineering Sample)

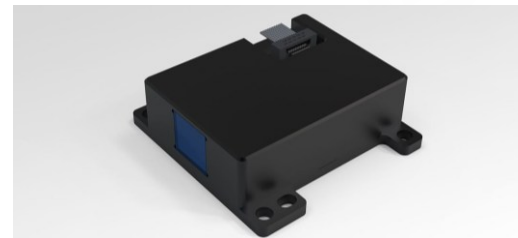

905nm 700W EEL
Line Beam Transmitter

LX02 (Engineering Sample)



VCSEL Line Transmitter 1000W

Optical Components and Assemblies for Automotive

EEL FAC Collimators

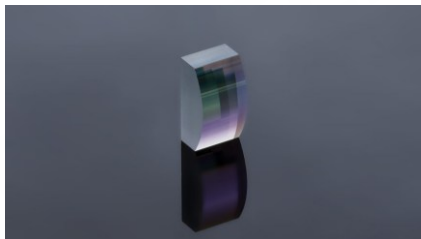

Auto-grade Diffusers and Homogenizers

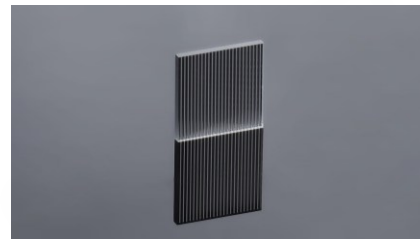

Optics for Automotive Projected Lighting and Headlight

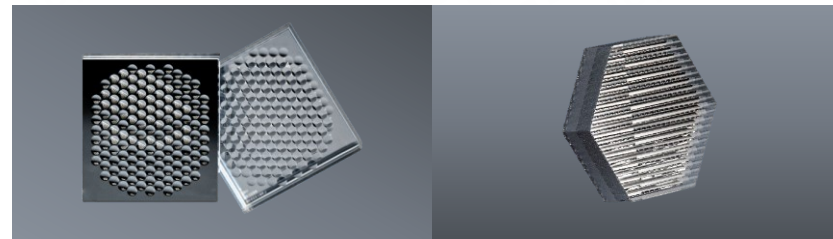

Customized Optical Assemblies

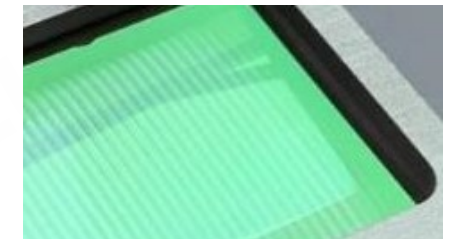

Products - Pan-Semiconductor Application Solutions

Under Focuslight Brand

Advanced Display Manufacturing Solutions



Solid-State Laser Lift-Off (LLO) System



Solid-State Laser Annealing (SLA) System



Variable Beam Laser System
(Mini and Micro LED Processing)

IC Manufacturing Processing



IC Wafer Annealing System



Variable Beam Laser System
(Advanced Chip Packaging)

Industrial Solutions



IR Line System

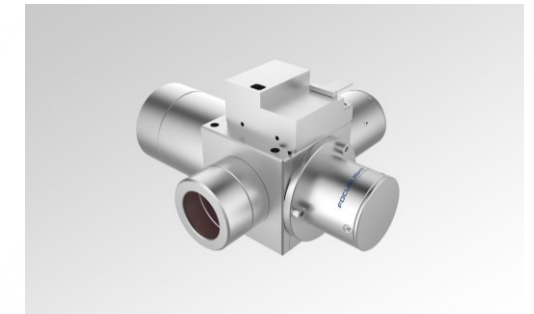

Industrial Laser Module

Products - Medical and Health Application Solutions

Under Focuslight Brand

**Laser Hair Removal
Modules**



**Laser Skin Rejuvenation
Modules**

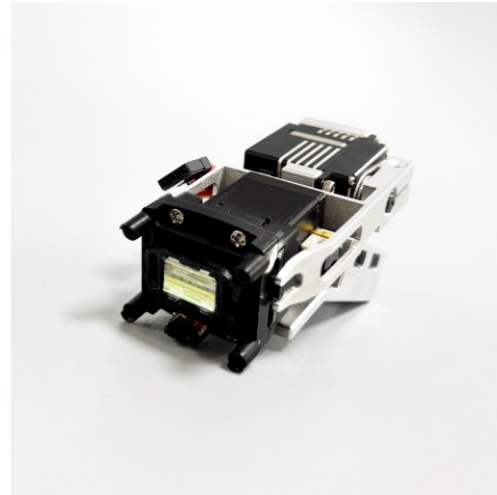

**Laser Body Sculpting
Modules**



Diode Laser Drivers



Global Photonics Foundry Services

Under Heptagon Brand

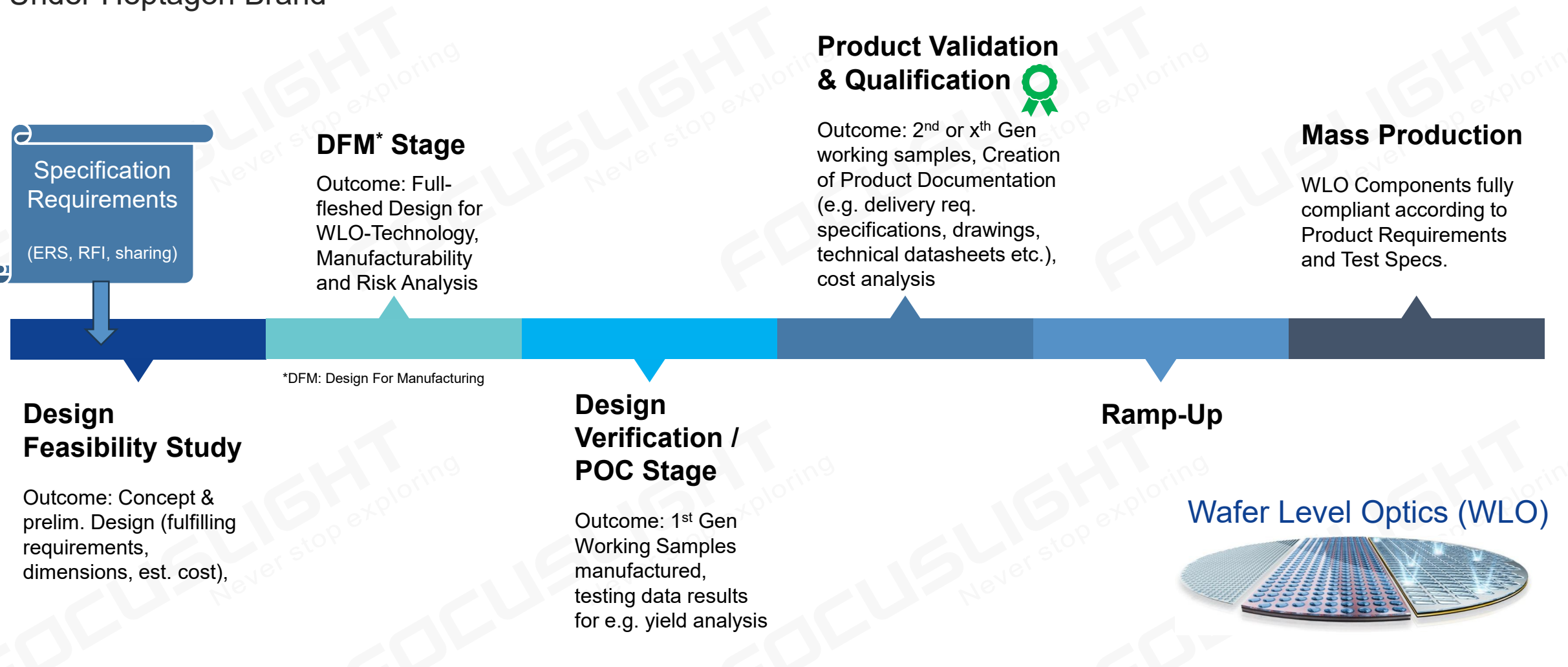

Work with Us – From Concept to Mass Production

Core Competence

Diode Laser

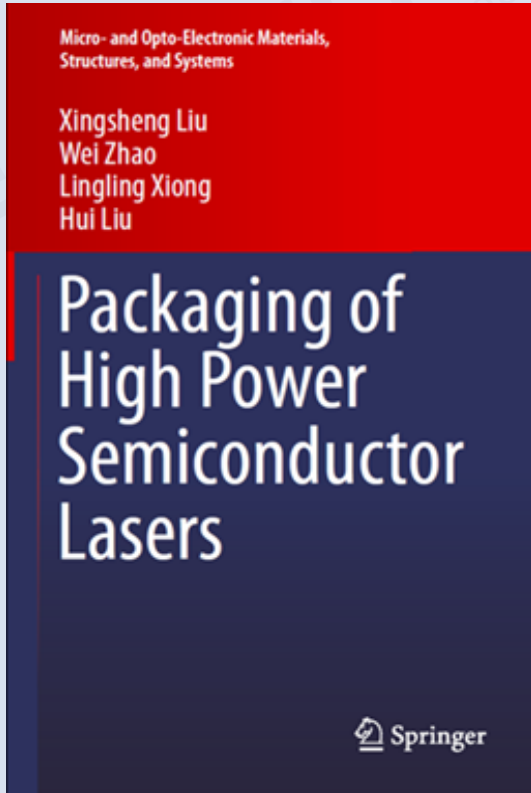

Eutectic Bonding

High Reliability

Carrier with Pre-deposited AuSn solder layer

Bar

Solder

Heatsink

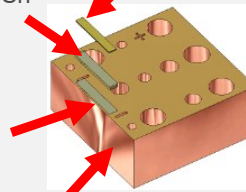

Thermal Management

Finite Element Thermal Analysis and Design

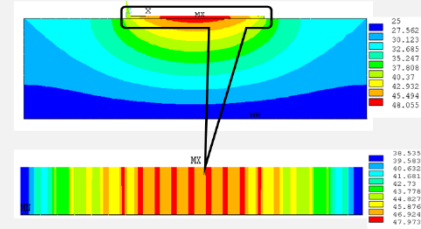

Thermal Stress Control

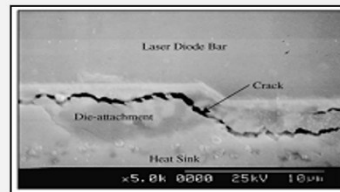

Interface Materials and Surface Engineering

Solder nonwetting

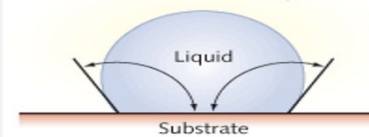

Solder wetting

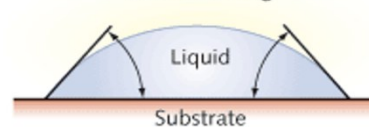

Test, Analysis and Diagnosis

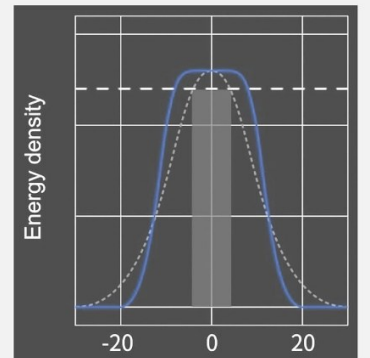

Core Competence

Beam Shaping – *The Right Photon at the Right Place and Time!*

Micro Optics Design and Simulation

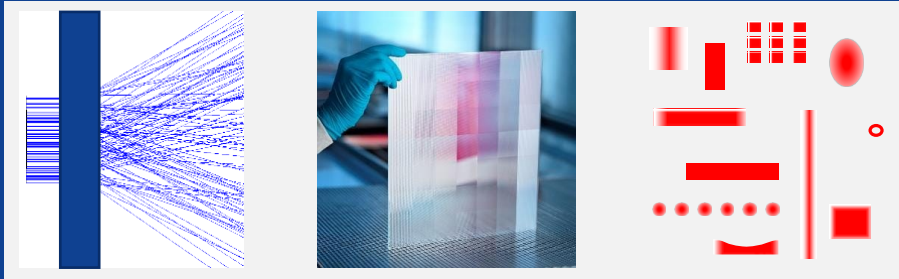

Acylindrical free-form micro-optics / arrays / diffusers / DOE splitters / beam shaping systems

Homogenization

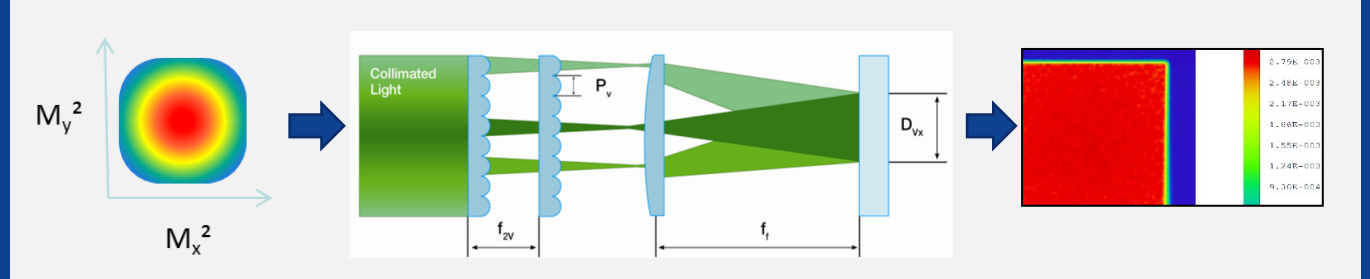

Uniform and homogeneous illumination in any desired shape

Beam Transformation

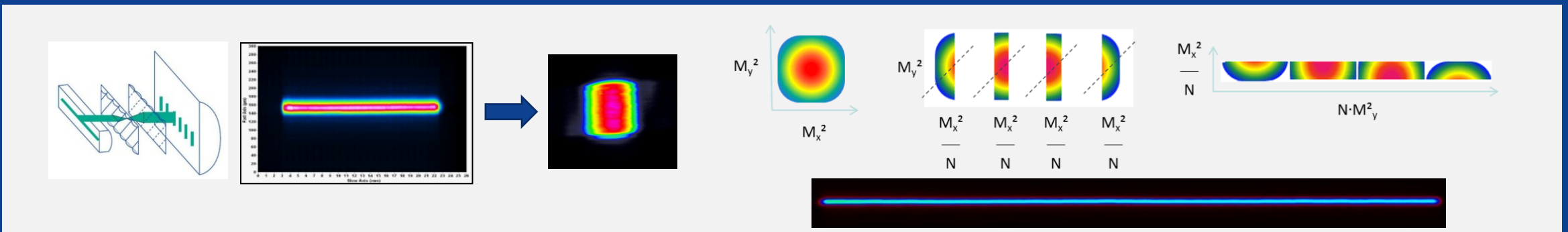



Asymmetrical → Symmetrical beam

Symmetrical beam → High density line beam

Core Competence

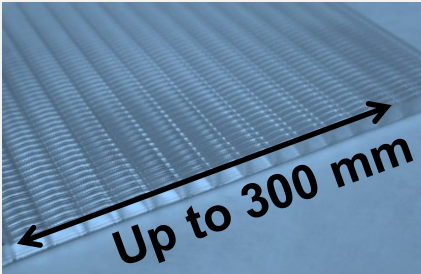
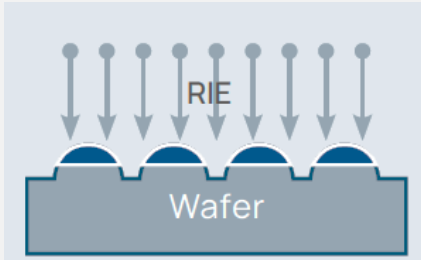
Optics Manufacturing

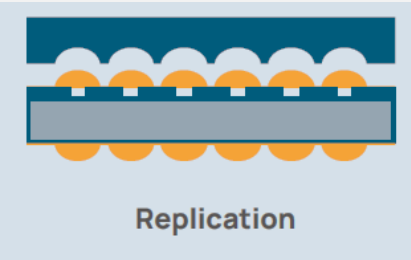
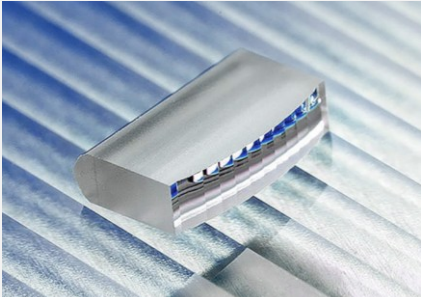
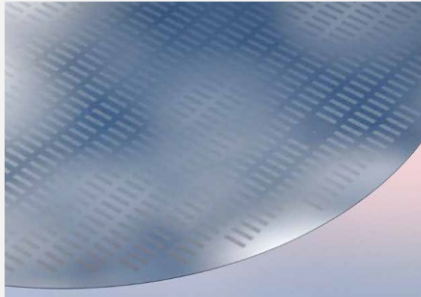
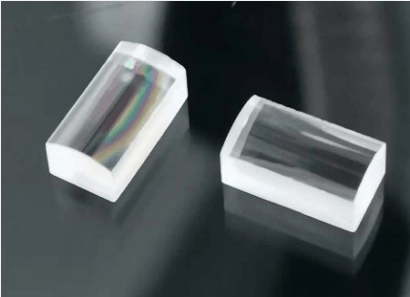
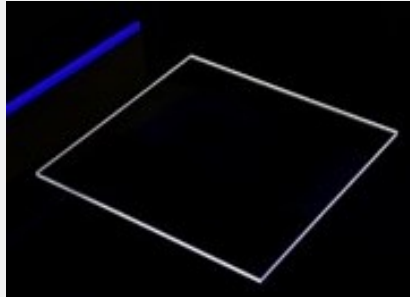
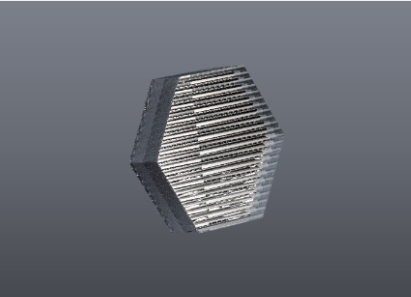
Wafer Level Simultaneous Structuring	Wafer Level Photolithography-RIE (reactive ion etching)	Precision Glass Molding	Cold Processing	Imprinting
	 <p>RIE Wafer</p>			 <p>Replication</p>
				
<p>With inorganic materials: Glass, Fused Silica, Silicon, CaF₂</p>				<p>With polymer on glass</p>
<p>High LIDT Optical Coating: Anti-reflection, high-reflection, beam splitter, band filter, and various customization (UV, VIS, IR)</p>				

Core Competence

Wafer Level Optics and Stacking

Wafer-Level Optics, Electronics, Packaging, Integration, Testing and Processing

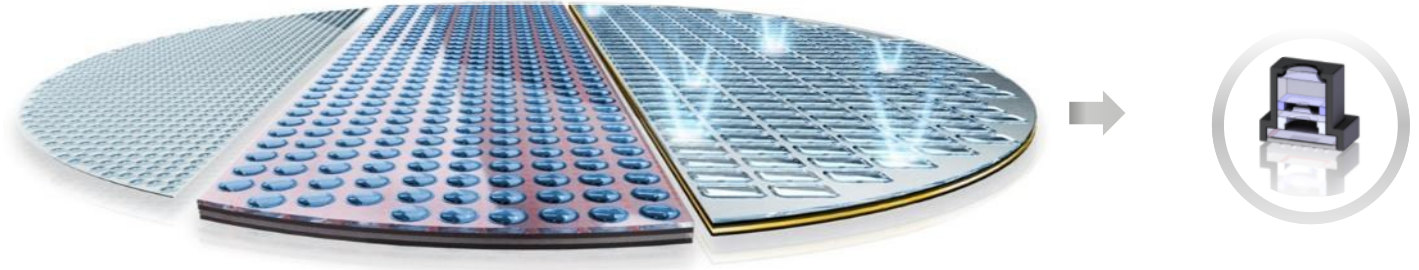

Wafer-level imprinted optics from mm down to nm-scale

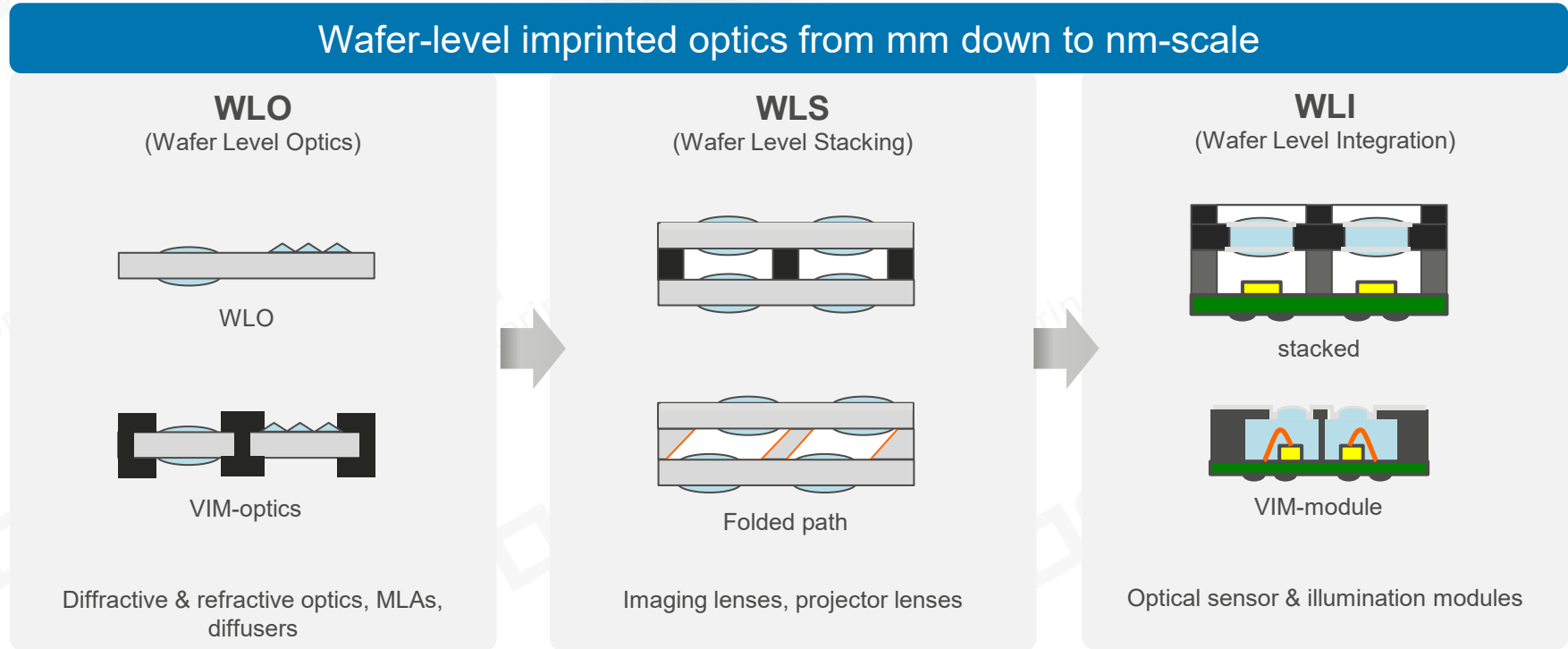
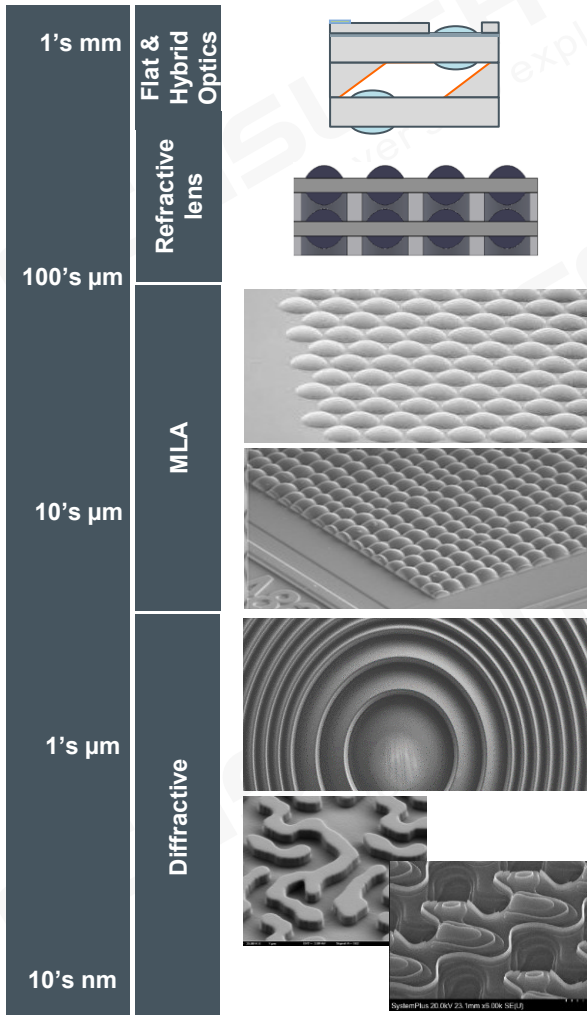

Core Competence

High Precision Optical Assembling Process and in-house Equipment: From Components to Subsystems

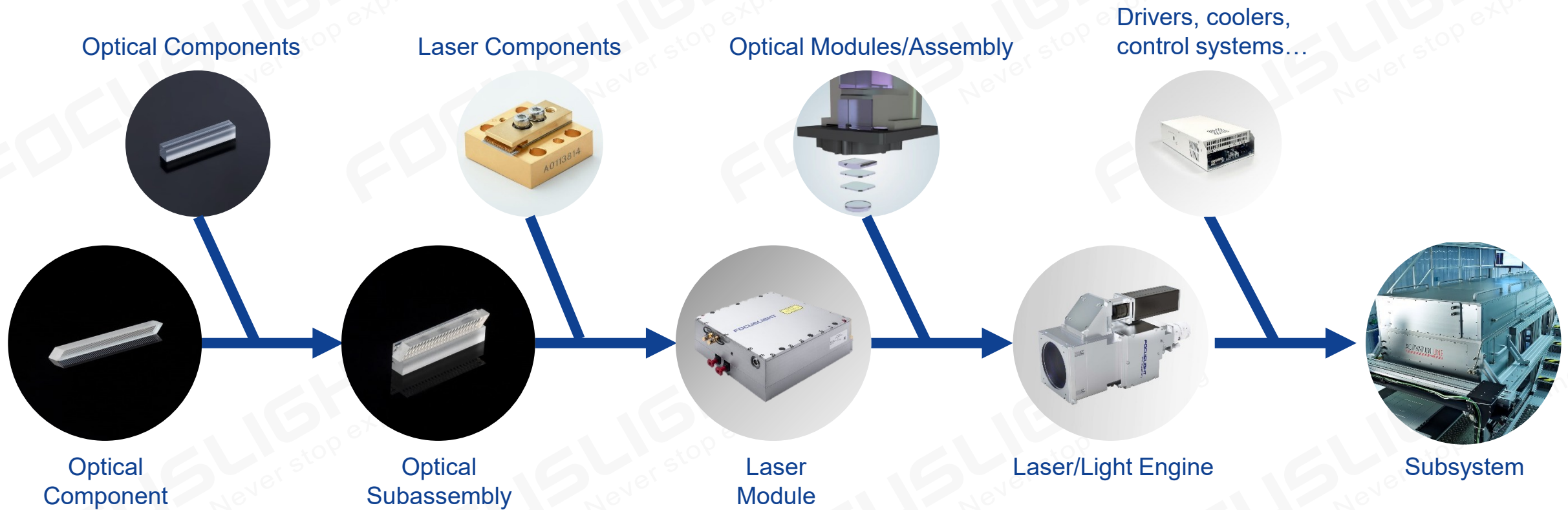

A Unified QM System in the Corporate Ensures Reliable and Premium Products

ISO9001 Certified Quality Management System (QMS)

ISO14001 Certified Environmental Management System (EMS)

IATF16949 Certified Automotive Quality Management System

ISO45001 Certified Occupational Health and Safety Management System

Failure Mode and Effect Analysis (FMEA)

Statistical Process Control (SPC)

Production Traceability Database

Control Plan (CP)



Quality Assurance System

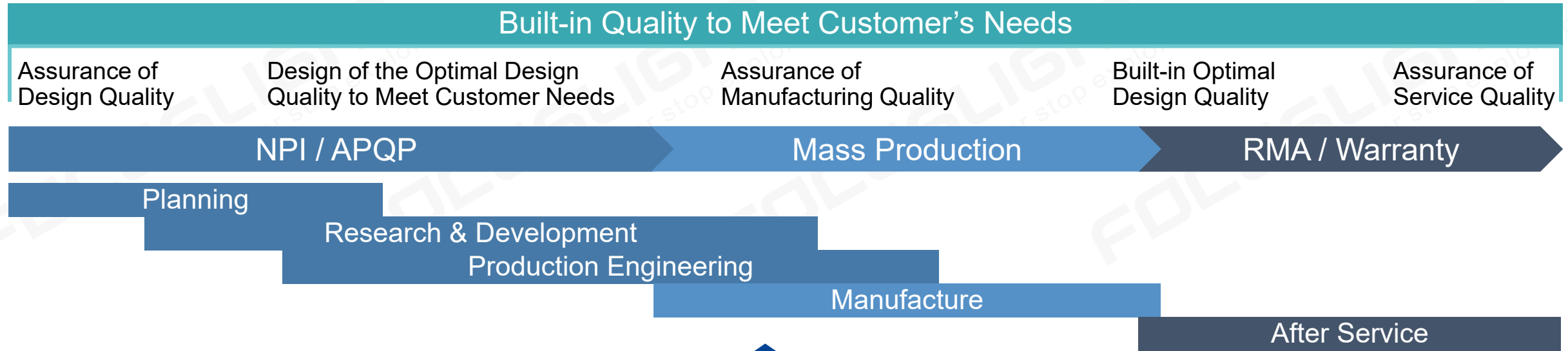

Promotion of Consistent Quality Assurance Activities

Quality Control System of Design	Quality Control System of Manufacture		Quality Control Evaluation System
<ul style="list-style-type: none"> • QFD • Critical Characteristic, Special Characteristics • Tolerance Chain Design • FMEA, FTA • Design Validation • Design Review 	<ul style="list-style-type: none"> • Parameter design • Process FMEA • Process Capability Study • Automatic Inspection, • Poka Yoke / Error Proof • Measurement System Analysis 	<ul style="list-style-type: none"> • QA Network • Supplier Quality Management • Production Validation • Control Plan • QC Circles • Production Part Approval Process 	<ul style="list-style-type: none"> • QC diagnosis • Quality assurance Meeting • Quality Auditing Improvement Meeting

Focuslight Manufacturing System (FLMS)

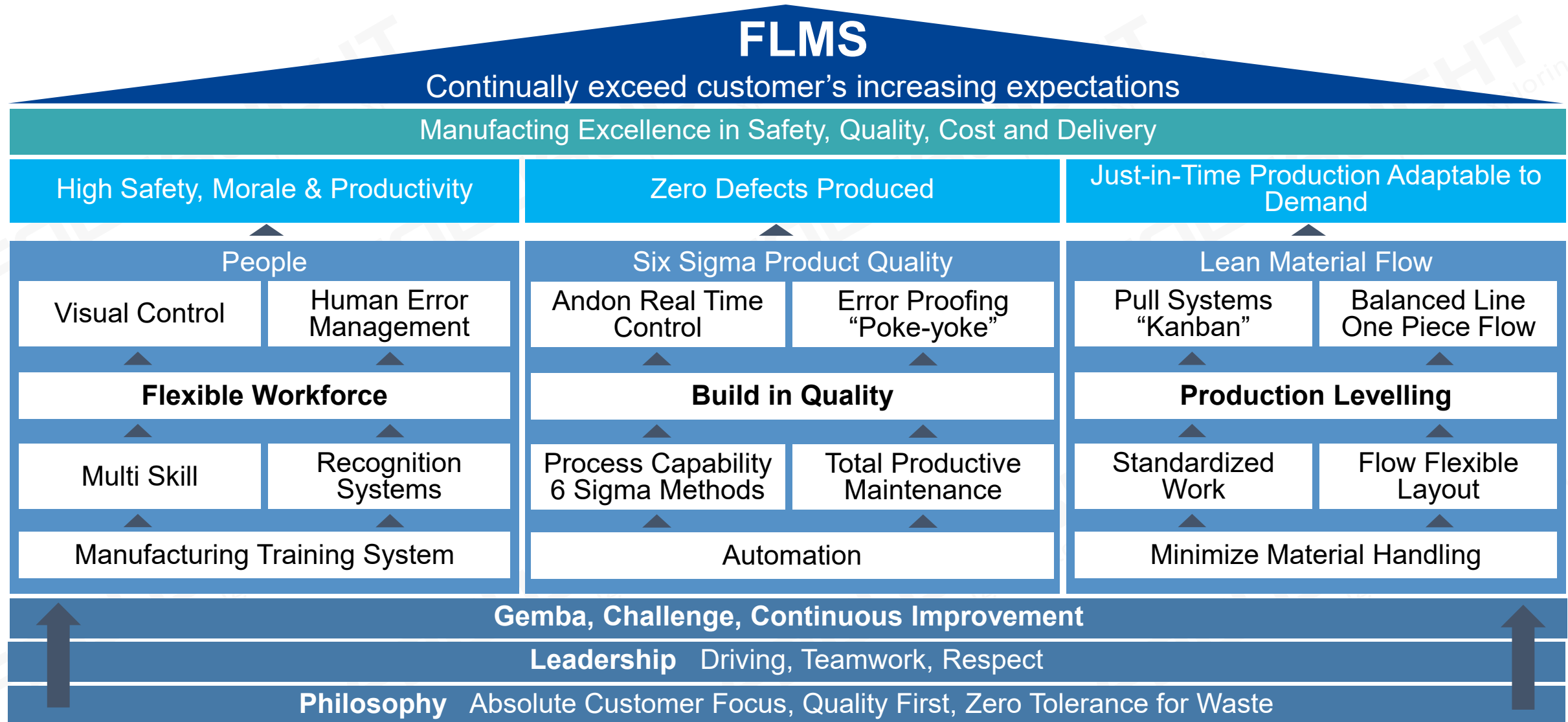

Manufacturing Excellence

- Apply the **lean manufacturing practices** to all production lines, including automotive, diode laser and laser optics business
- **Absolute customer focus, zero tolerance of waste, and continuous improvement** philosophy
- **Significantly reduced** cycle time, improved manufacturing efficiency, and lowered RMA yield and manufacturing cost.
- Adopting **automation and advanced production management system**
- **SOP** of the first LiDAR transmitter project with an international automotive tier 1 customer
- IATF 16949 certified and VDA 6.3 audited



Manufacturing Capacity

Advanced Materials

10+ years high-volume manufacturing experiences + self-owned core technologies

DPC production



Etching production

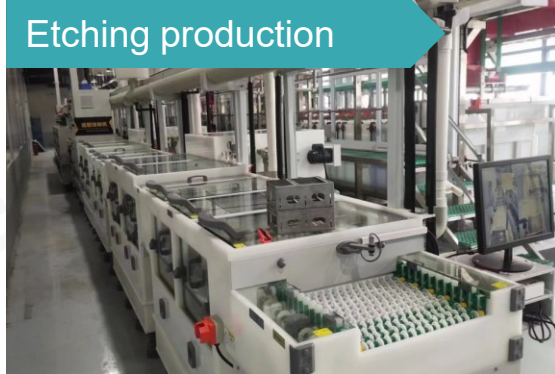

Au plating



Pattern production

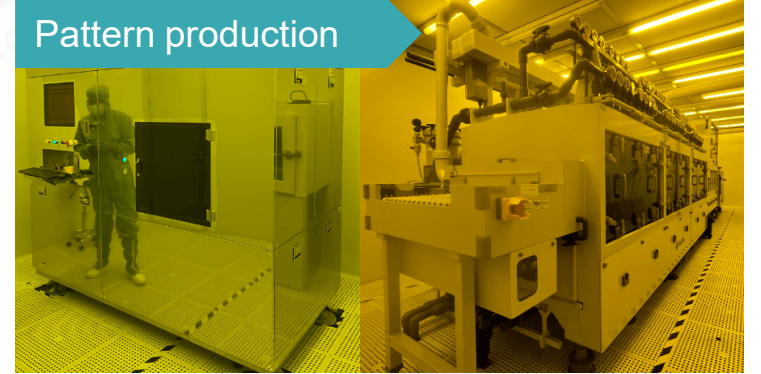

Cleaning



AuSn deposition



Laser marking



Dicing



AOI inspection



Advanced Materials Manufacturing Capacity > 2M pcs / month

Manufacturing Capacity

Diode Laser Components

Packaging & Assembling



Optical Assembling



Testing & Measurement



Quality Inspection



Burn-in & Lifetime Test



Diode Laser Manufacturing Capacity > 500K pcs / year
Burn-in Capacity 600K pcs / year

Manufacturing Capacity

Laser Optics Components: Wafer-Level Simultaneous Structuring Processing

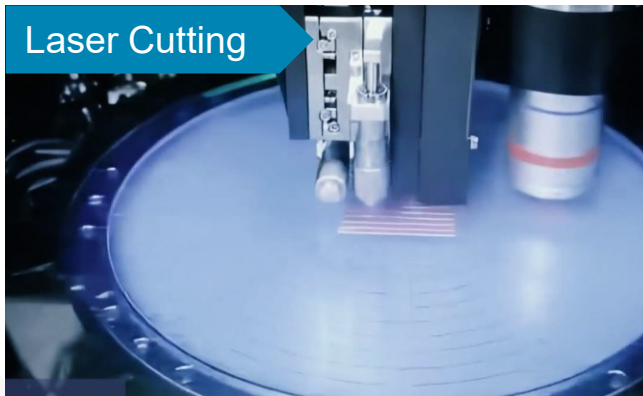
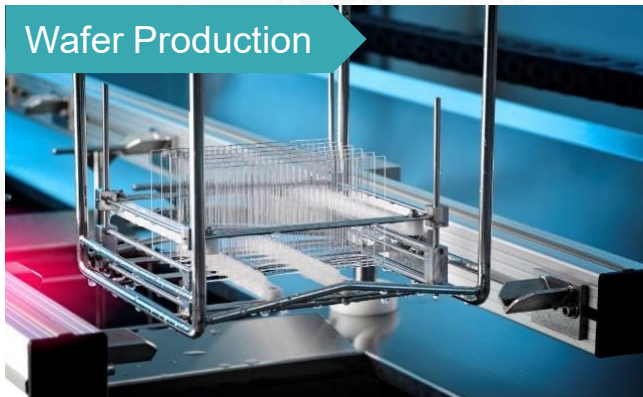

Wafer-Level Simultaneous Structuring Processing:
Manufacturing Capacity > 2K wafers / month or > 3.5M pcs lenses / month

Manufacturing Capacity

Laser Optics Components: Photolithography-Reactive-Ion-Etching Processing

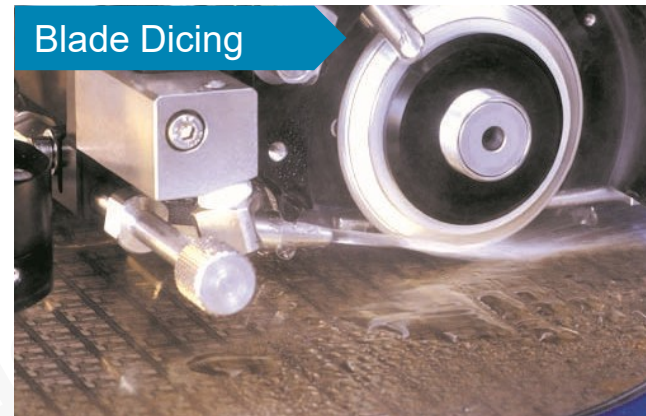
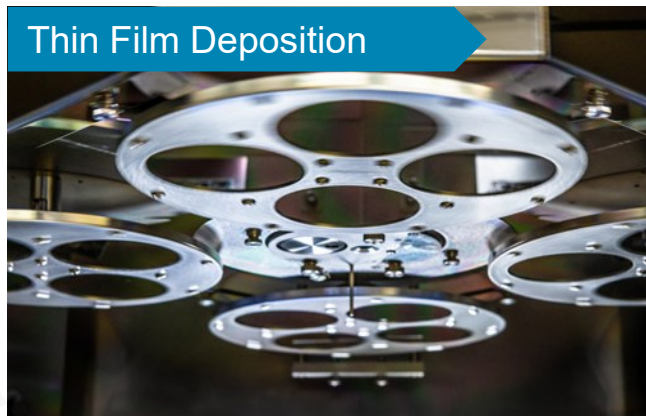
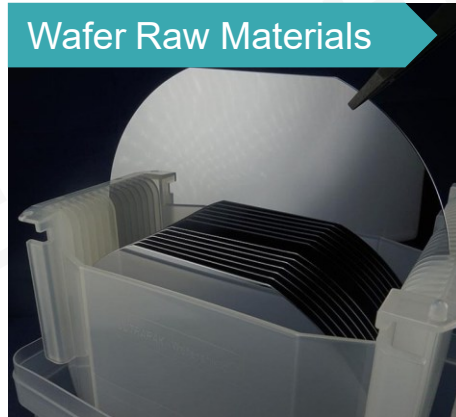

Photolithography-Reactive-Ion-Etching Processing:
Manufacturing Capacity > 300 wafers / month

Manufacturing Capacity

Laser Optics Components: Imprinting Processing

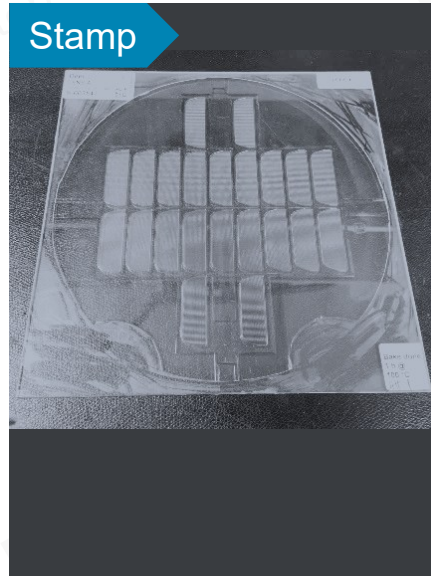
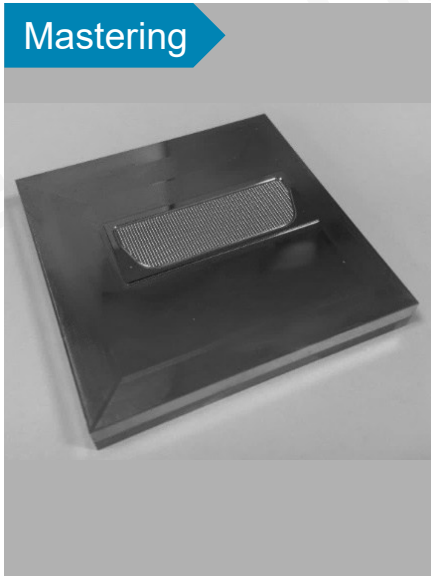

Imprinting Processing:
Manufacturing Capacity > 15K wafers / year or > 30M pcs lenses / year

Automation Powered Manufacturing Excellence

Automatic Optical Alignment

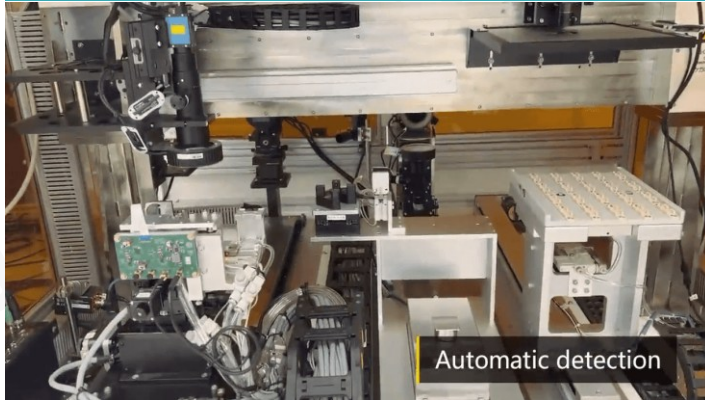

Automatic Assembly

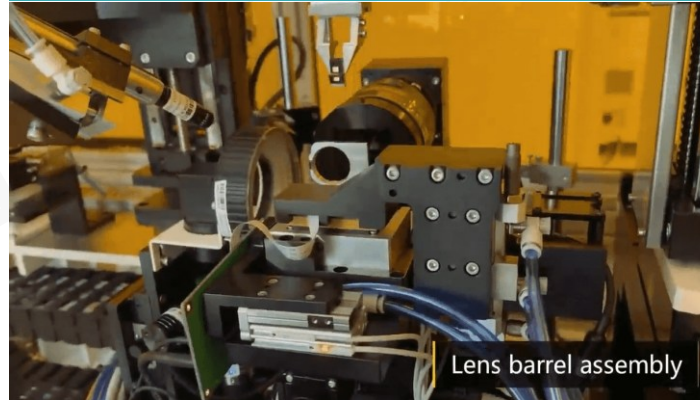

Automated Optical Inspection

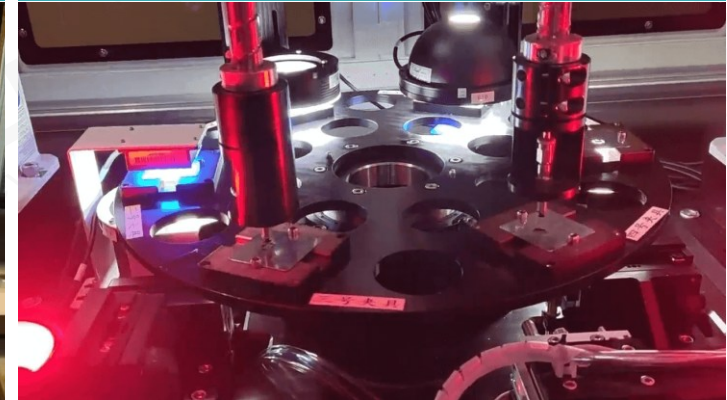

Laser Optics Production Line



LiDAR Transmitter Production Line



Video Link: <https://www.focuslight.com/news-events/newslst/focuslight-autonotation-powered-manufacturing-excellence/>

Typical Applications

Optical Communication

Diffractive and Refractive Optics

- Focusing / collimating microlens
- Prism integrated microlens arrays
- Microlens arrays
- Silicon refractive microlens arrays



Optical transceivers (TROSA, ROSA, TOSA *)

Optical Switches

Photonic Integrated Circuits (PICs)

Fiber Connectors

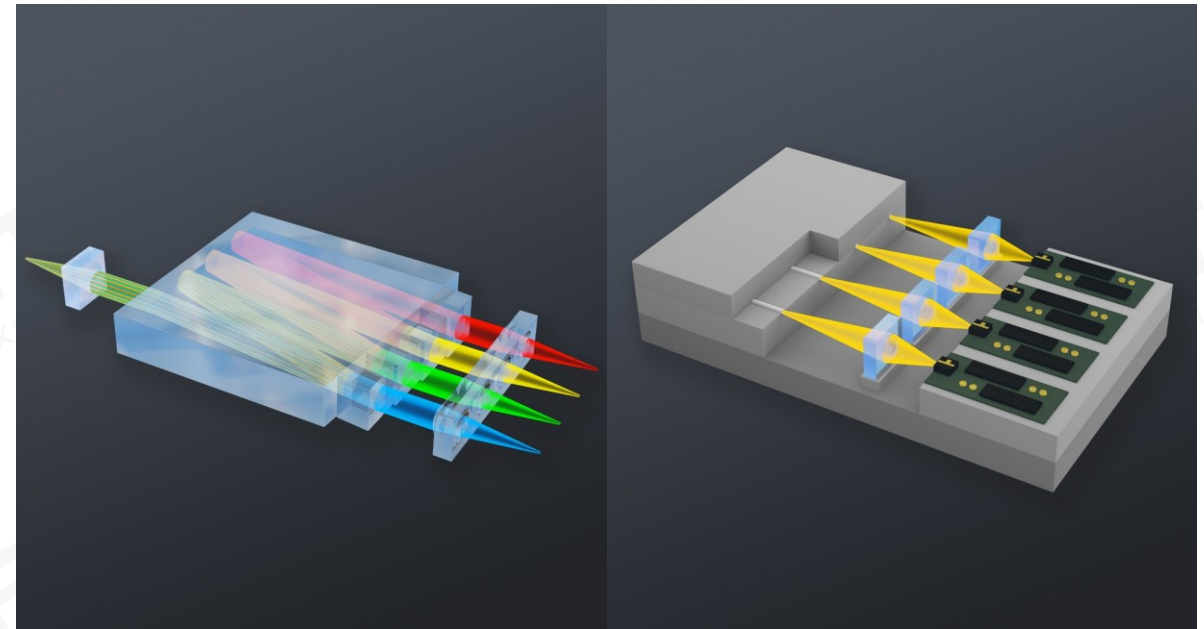
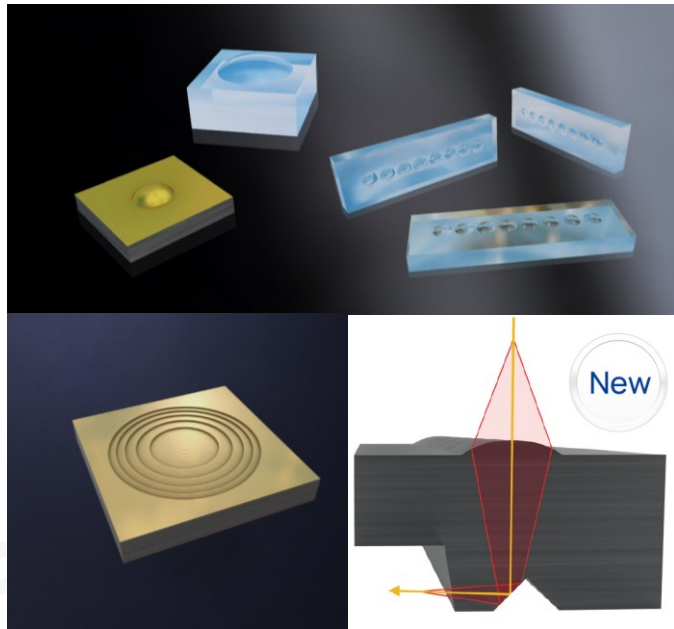

* TROSA = Transmit & Receive Optical Sub Assembly, ROSA = Receiver Optical Sub Assembly, TOSA = Transmitter Optical Sub Assembly

Typical Applications

Consumer Electronics

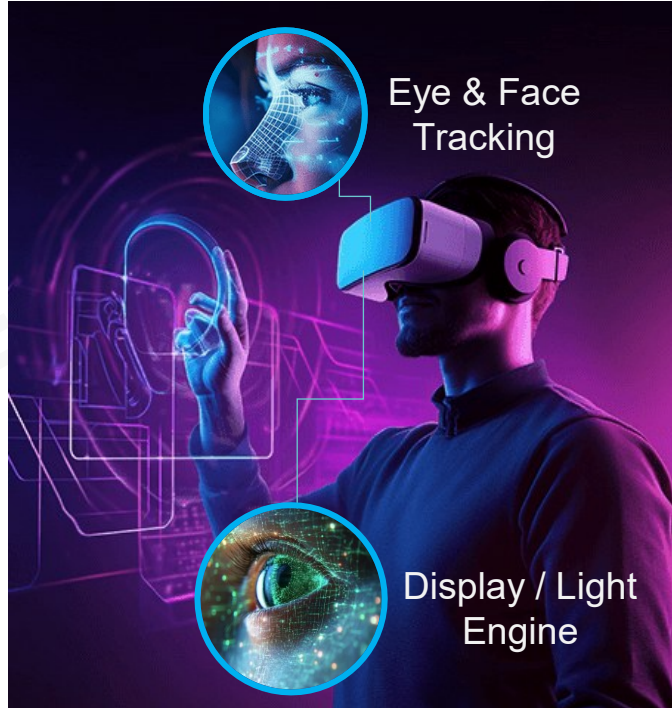

Tailored Diffusor Micro-Optics

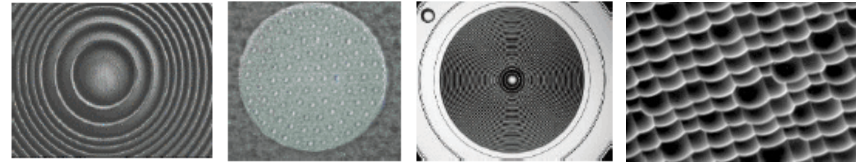

Fresnel lens, circular lens array, micro kinoform, irregular MLA for flood illum.

Pattern-Generating Micro-Optics

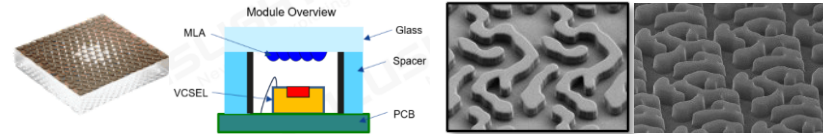

MLA-based dot projection modules

Binary DOEs for beam fanout; 3D-depth sensor



Imaging and Projection Micro-Optics



Multi-zone 3D-dToF sensors (~proximity sensors)



Eye- / Gesture- and World-Tracking Micro Camera Lenses



Multi-aperture WLO-lens for AR-μLED Display Engines

Typical Applications

Medical and Health



Hair Removal



Body Sculpting



Skin Rejuvenation



Ophthalmology



3D Interoral Scanning



Dermatology

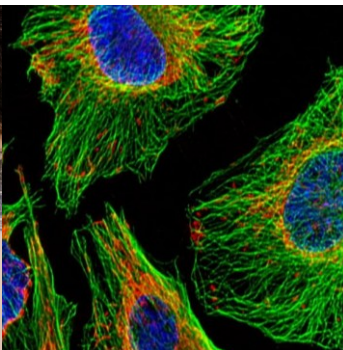

Confocal Microscopy



Endoscopy



Sensing



Laser Surgery



Optical Components;
Laser Components



Optical Solutions;
Laser+Optics Assembly;
Application Handpiece



Contract Manufacturing
Services



*Focuslight does not
produce medical or
health equipment*

Typical Applications

Automotive

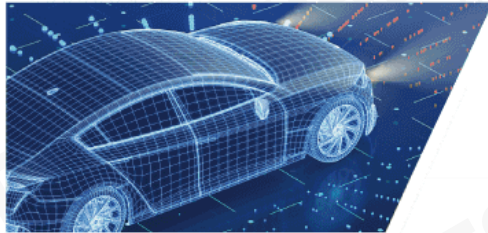

LiDAR



Driver Monitoring System



Smart Headlight



Projected Lighting



AR HUD



Optical Components



Laser Transmitter /
Illumination Modules



*Focuslight does not
produce LiDAR /
Lighting full system*

Typical Applications

Semiconductor

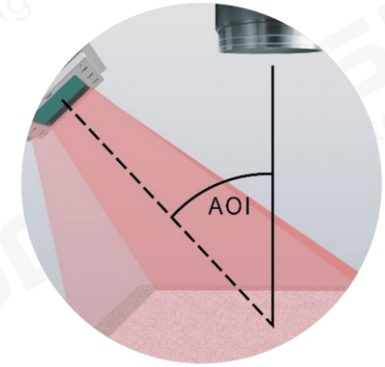
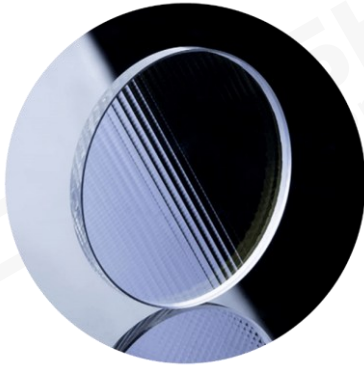

- Beam homogenization technology powers the illumination system – key optical component in **pan-semiconductor systems**
- > 15 years supply to the major manufacturer of semiconductor lithography tools

- Laser system solutions with high power density and different beam profiles, designed for various **laser-based wafer annealing processes** including IGBT backside annealing and SiC annealing

- Based on 976nm diode laser with adjustable beam output and >95% homogenization in energy distribution
- Ideal for **advanced chip packaging processes**, e.g. laser-assisted bonding

- Off-axis beam shaping technology powers laser surface treatment as well as surface inspection
- Typically used in **solar cell industry**

Typical Applications

Display



Solid-State Laser Lift-Off (LLO) for Flexible Displays

- Several tens of beam shapers (plasma display pixel structuring)
- Several green 100 mm line beam systems (laser lift-off)
- > 600 mm UV line beam production system (laser lift-off)

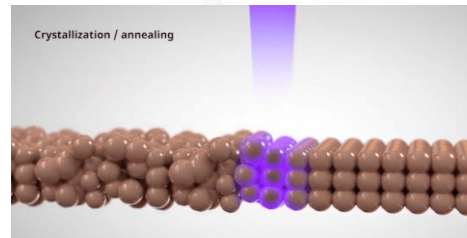

Next-gen LTPS Solid-state Laser Annealing Process

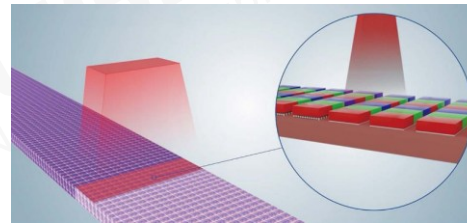

Mini and Micro LED Processing

- Laser Mass Transfer and Laser Mass Soldering
- Laser Chip Repair



Typical Applications

Industrial

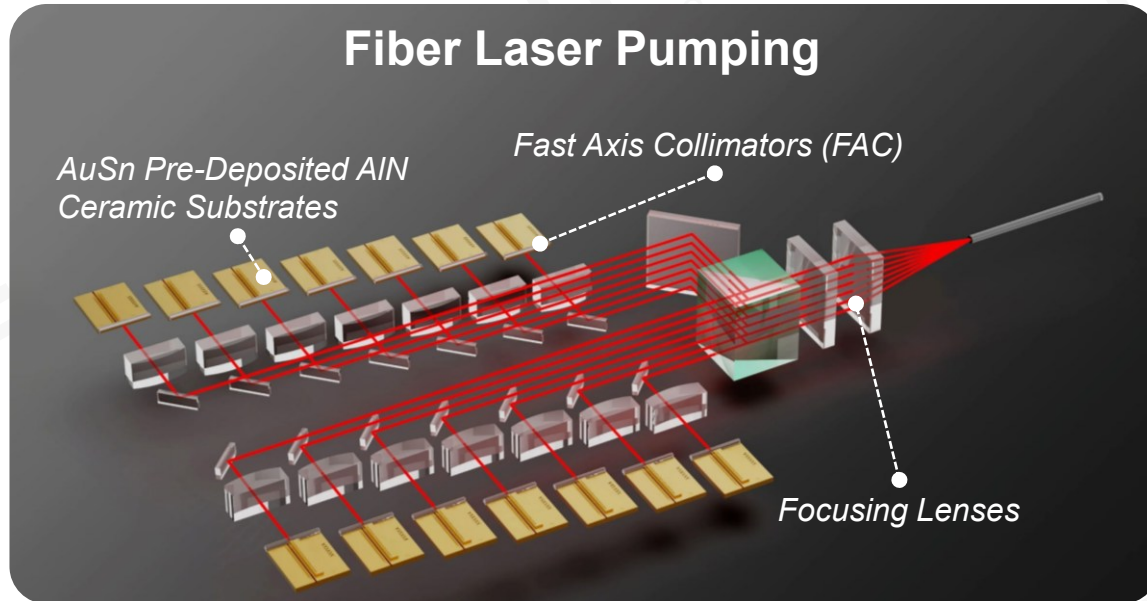

- **AuSn pre-deposited ceramic substrates** – stable and reliable thanks to the high thermal conductivity and suitable thermal expansion coefficient;
- **Fast axis collimators (FAC)** – fundamental and efficient solutions for shaping the beam emitted by the pumping sources;
- **Focusing lenses** – coupling the collimated laser beam precisely into the output fiber;

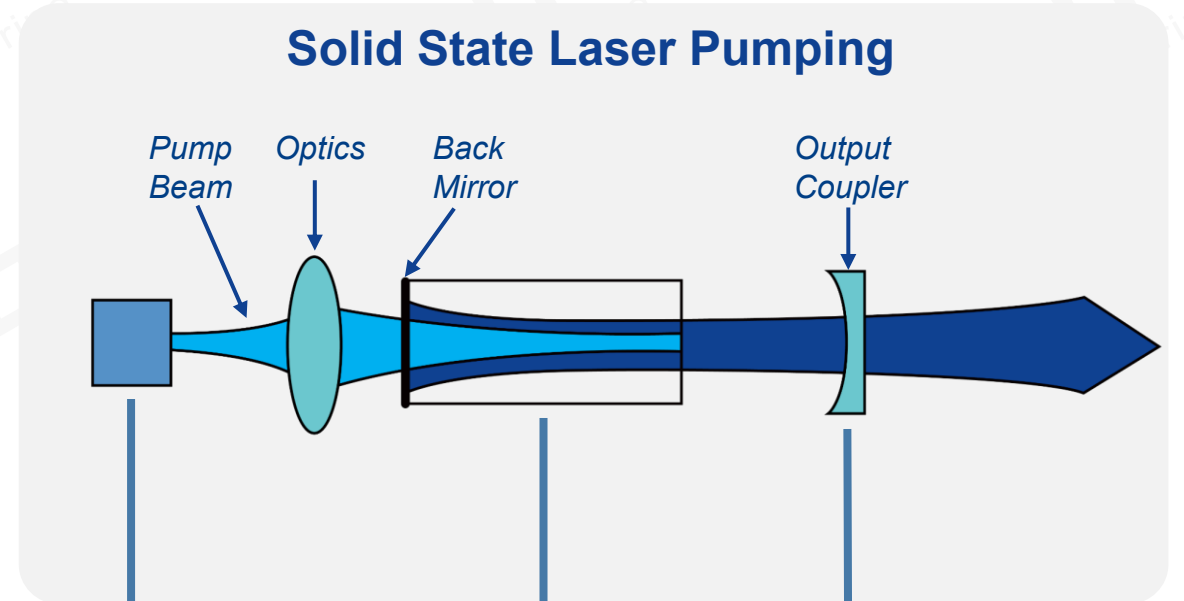

Diode Laser as Pumping Source

+

Gain Medium

+

Optical System

Footprint ↓

Reliability ↑

Efficiency ↑

Cost ↓

Sales Network

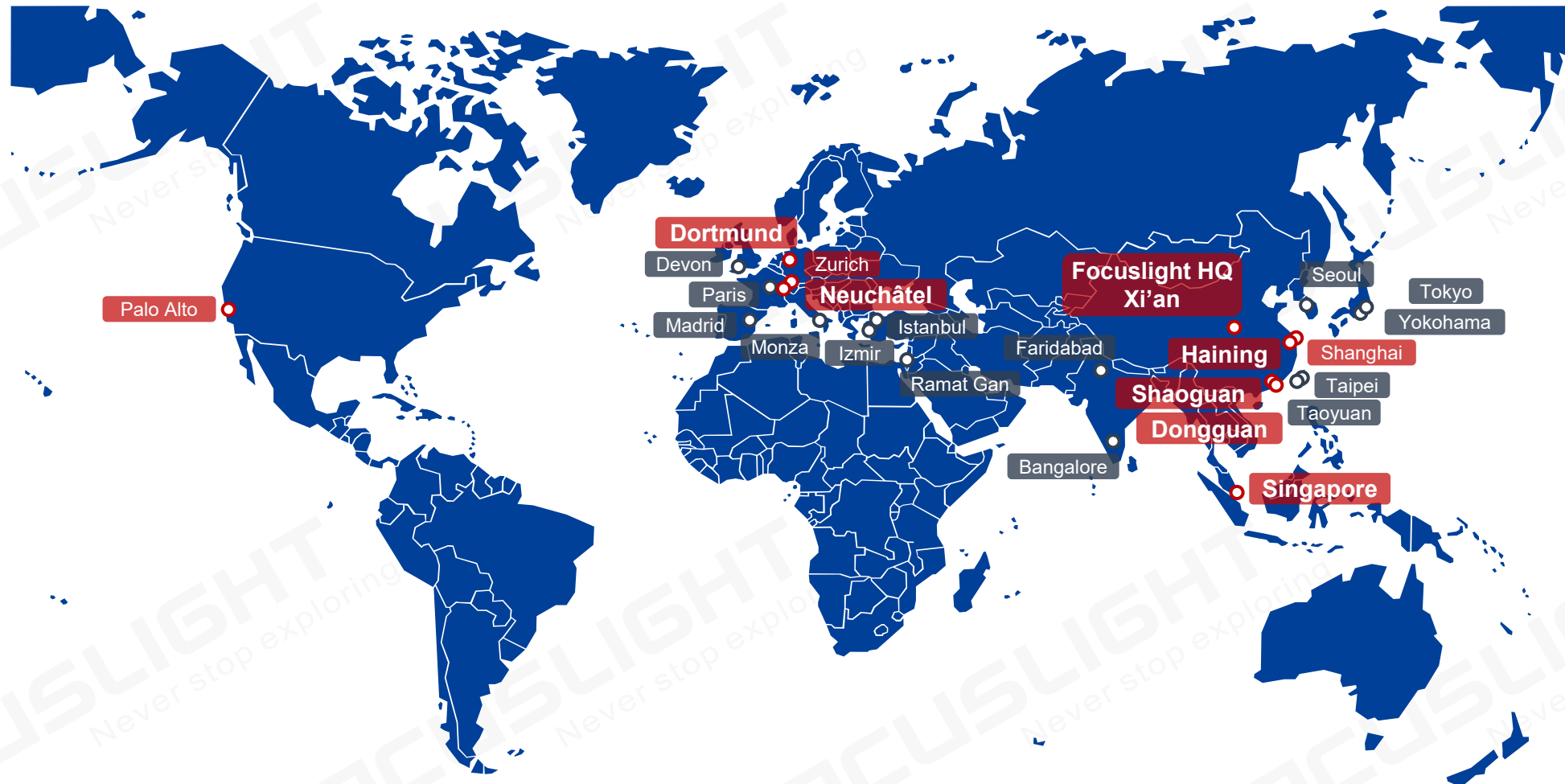

- Worldwide established distributors
- Direct sales offices in China, Switzerland and US
- Manufacturing site in Xi'an, Dortmund, Dongguan, Haining, Shaoguan, Neuchâtel, and Singapore

Your committed and reliable long-term partner in photonics components and solutions



Diode laser light source leader and beam shaping expert with strong IP position



One-stop-shop provider of micro-optics choosing from five process technologies best matching customer needs



Global photonics foundry that convert customers' ideas and designs into their own products and solutions



Total solution, versatile customization service and field service provider



Strong RDE capability, high volume production capacity and low-cost manufacturing



Financially healthy and strong financial backing from investors for long term growth

THANK YOU



www.focuslight.com

www.hptg.com

